

MODEL MQ2040T

PEAK MARQUEE TENT

ASSEMBLY INSTRUCTIONS

IMPORTANT:

PLEASE READ INSTRUCTIONS PRIOR TO ERECTING THE TENT.

PROPER INSTALLATION WILL ENSURE MAXIMUM USAGE AND STABILITY OF THIS STRUCTURE.

IF FURTHER INFORMATION OR CLARIFICATION OF ANY PART OF THE ENCLOSED INSTRUCTION IS REQUIRED, PLEASE CONTACT:

WARNER SHELTER SYSTEMS LIMITED
1-800-661-6155 OR E-MAIL: warner@wssl.com

CAUTION

1. Each installation site must be evaluated and the proper securing method determined by the installer. Some soils require staking or securing different from that which was provided with the tent.
2. Good judgment and common sense must be used along with installation guidelines. It is the responsibility of the tent installer/maintainer to anticipate the severity of the weather along with the proper time and method of setup and take down. Evacuation of the tent is recommended before weather becomes extreme. A successful event is a safe event.
3. Proper safety equipment, such as hard hats, steel toe shoes, and safety glasses, should be used to ensure a safe setup and take down.

Table of Contents		PAGES
1.)	TENT LOCATION.....	2
2.)	PARTS LIST.....	3 - 4
3.)	FRAME ASSEMBLY	4 - 5
	Post & Centrepole Assembly Step 2.....	PAGE 4
	Upper Frame Assembly Step 3 - 4	PAGE 4
	Cross Cable Installation Step 5 - 6	PAGE 5
	Cable: Slide Wall Installation (optional) .. Step 7.....	PAGE 5
4.)	TENT TOP INSTALLATION	5 - 6
	Protecting Tent Top Step 8.....	PAGE 5
	Unfolding Tent Top Step 9	PAGE 6
	Securing Tent Top to Frame Step 9A/9B & 10	PAGE 6 - 7
5.)	ERECTING THE TENT	7 - 10
	Installing Posts Step 11	PAGE 7
	Installing Centrepole Step 13 - 19	PAGE 8 - 9
	Securing the Structure Step 18 & 20	PAGE 10
6.)	GUY ROPE INSTALLATION	10
7.)	WALL INSTALLATION.....	11
8.)	JOINER INSTALLATION	12 - 13
9.)	SUMMARY	14
10.)	CARE FOR YOUR VINYL TOPS	15
11.)	MAINTENANCE	15

Tent Location

VERY IMPORTANT!
Ascertain tops, guys, and other tent parts are in good operating condition. Any components showing damage should be replaced immediately.

Before unloading, review the proposed location of the tent. In doing so, take into account the following:

- Hazards** Locate, mark, and avoid any overhead or underground electrical, phone, gas, sprinkler or other lines. Take note and always be aware of any and all hazards. **DO NOT BEGIN ANY ASSEMBLY UNTIL THE HAZARDS HAVE BEEN MARKED AND CAN BE SAFELY AVOIDED.**
- Access** Plan the best route for bringing the tent and equipment for the setup onto and off the site.
- Drainage** Attempt to influence the location of the tent so that rain or melting snow can drain away.
- Obstacles** A clean, level and unobstructed site will provide an easy assembly of the tents.
- Weather** Do not attempt to setup the tent during thunderstorms, high winds or other extreme conditions.
- Safety** Before the set up, instruct the crew on safety procedures. All local safety and fire regulations must be followed.

ALL SITE PERSONNEL MUST FOLLOW OCCUPATIONAL HEALTH AND SAFETY PROCEDURES.

MODEL MQ2040T PEAK MARQUEE TENT

CAUTION: Toggle ropes must be maintained tight and even for proper tensioning of the canopy fabric. The fabric must remain taut to avoid rain ponding.

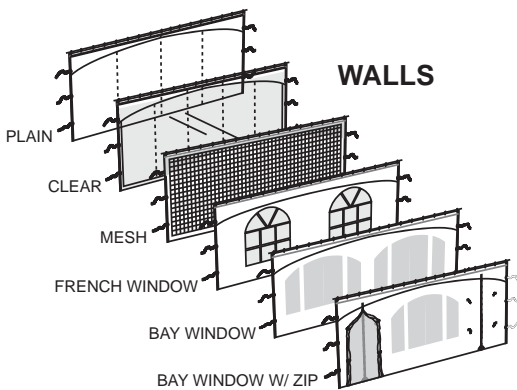
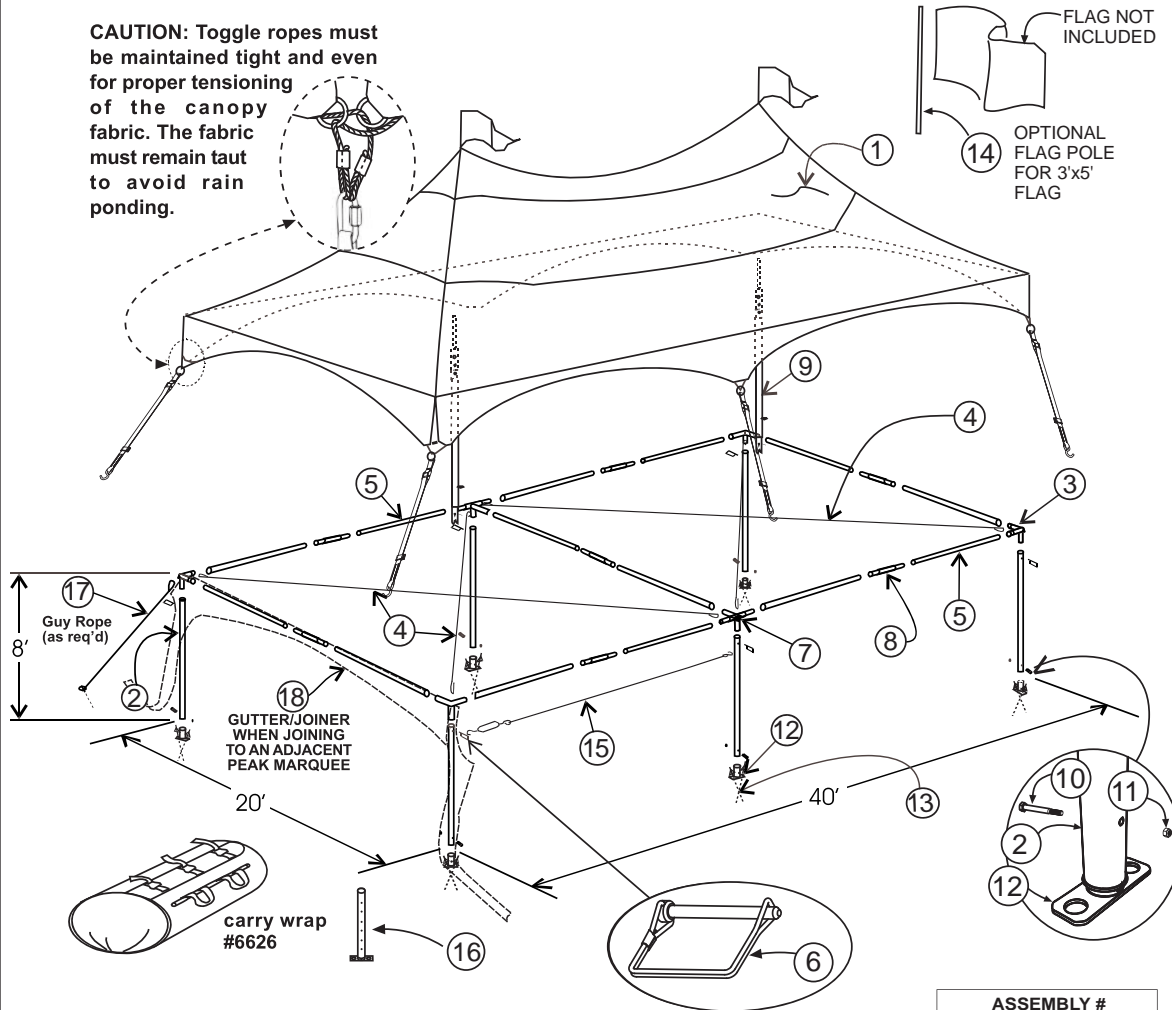

ITEM	PART	QTY	ASSEMBLY #	
			11964 ALUMINUM FRAME	10605 STEEL FRAME
①	TENT TOP MQ2040T	1	11565	
②	POST 8'	6	10591	10590
③	CORNER 90°	4	10628	
④	CROSS CABLE	4	7295	
⑤	EVE TUBE 9'3"	14	10630	7161
⑥	LOCKPIN	8	7843	
⑦	T-PLUS	2	9465	
⑧	MID JOINT	7	10667	7284
⑨	CENTREPOLE	2	10978	
⑩	BOLT 5/16-3 NC PL GR 5	6	04093	
⑪	NUT 5/16 NC PL NYLOK	6	08369	
⑫	BASE; MQ FLAT	6	10514	
⑬	STAKE 3/4" x 34"	18	10666	
⑭	FLAG POLE EXT.	2	9523	
⑮	CABLE: SLIDING WALL 20' as req'd		10673	
⑯	BASE: MQ ADJ. 24"	6	11064	
⑰	GUY ROPE	6	10689	
⑱	GUTTER/JOINER 20' as req'd		10959	
	DROP SHEET	1	10580	

Step 1

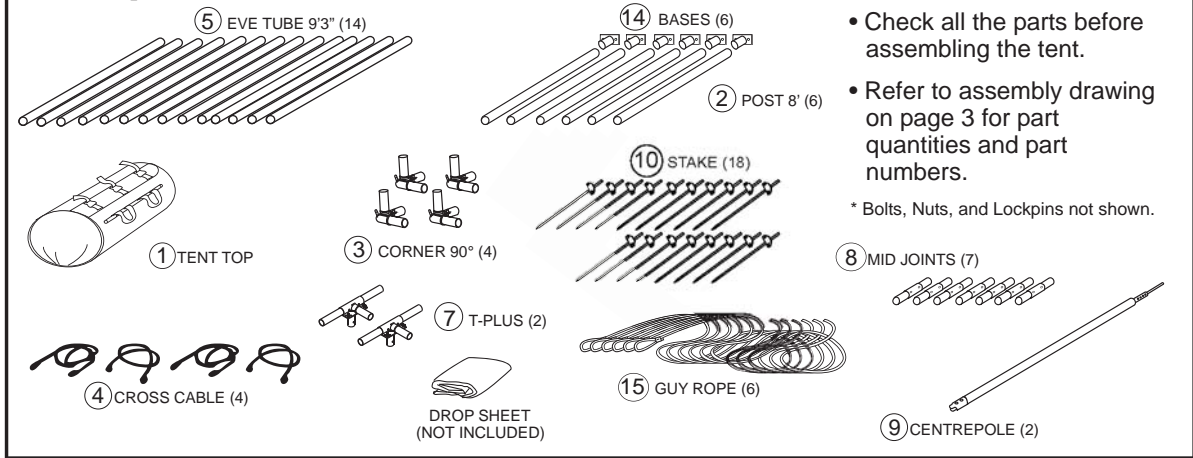

PRE ASSEMBLY

Step 2

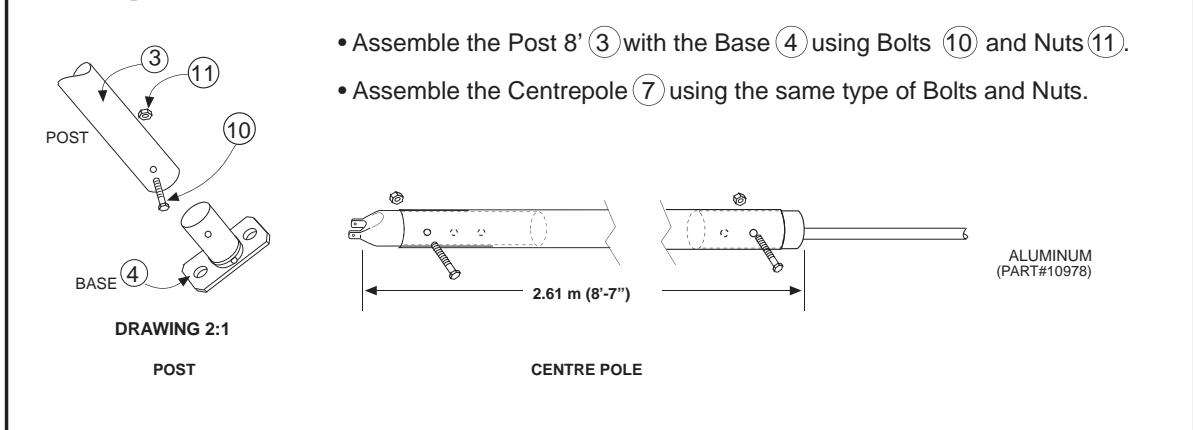

FRAME ASSEMBLY

Step 3

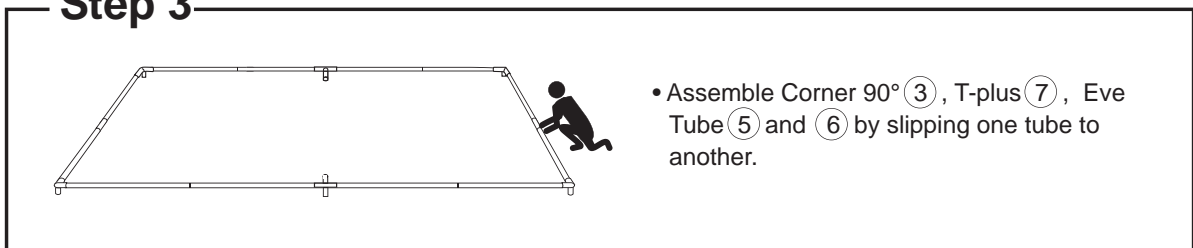

Step 4

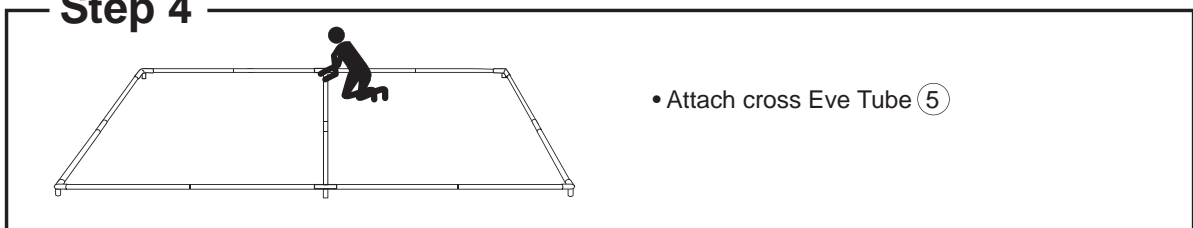

Step 5

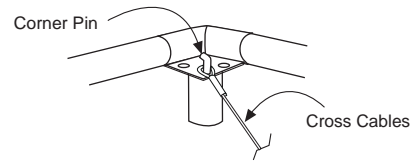
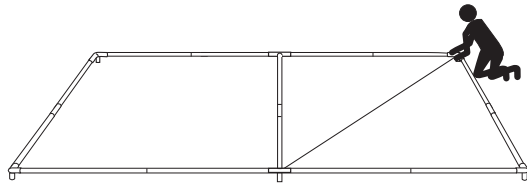

- Install first (bottom) Cross Cable ④ diagonally in square frame.
- Hook the cable end loop over the corner pin.

Step 6

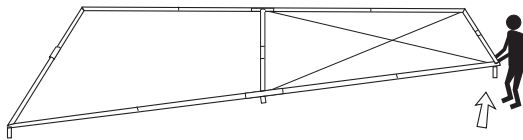

- Install second (top) Cross Cable.
- To install last loop, lift last corner to shorten the distance and hook the cable in place.
- Lowering the corner causes the corners to adjust their position and the cables to tighten.
- Repeat steps 5 and 6 for the opposite side of the tent

Step 7

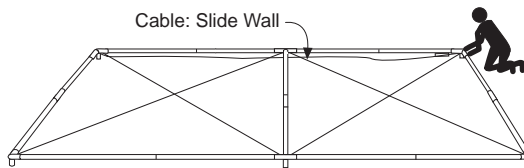

- **If walls are to be installed**, attach Cable for SlideWall ⑬ to the Corners and tighten turnbuckle.

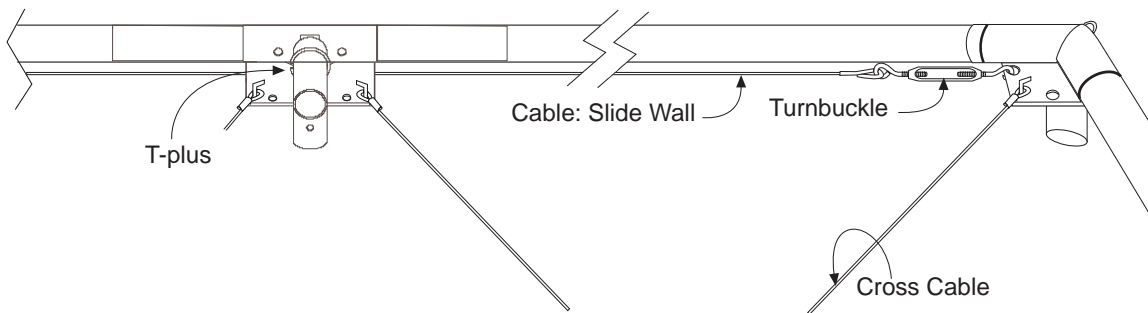

TENT TOP INSTALLATION

Step 8

PROTECTING TENT TOP

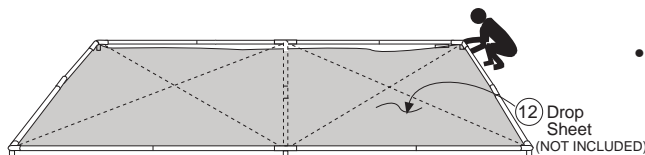

- Unfold Drop Sheet (not included) over the Cross Cables to protect the Tent Top and to keep the Tent Top clean.

ERECTING THE TENT

Step 9

UNFOLDING THE TENT TOP

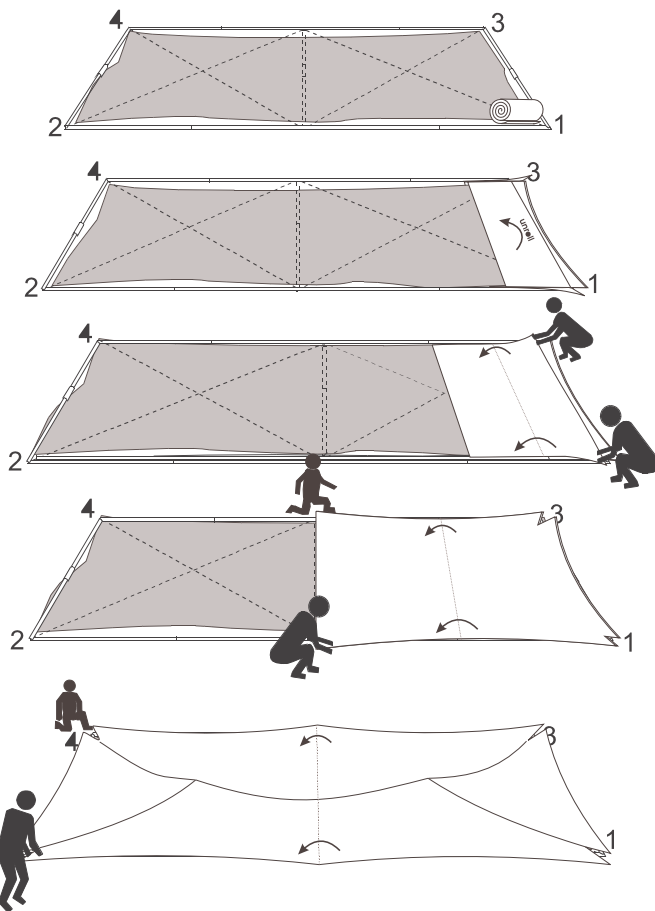

NOTE: The corners are numbered here for explanation only.

- Place the Tent Top midway along one side and unfold fabric toward the corners.
- Ensure that the valences are against the outside edge of the frame.
- Attach webbing, as shown in **Step 9A**, to corners 1 and 3.
- Pull upper layer towards the opposite end. Use toggle rope to avoid stepping on Tent Top.
- Attach webbings, as shown in **Step 9B**, to corners 2 and 4.

ATTACHING WEBBING TO CORNER LOOP

Step 9A

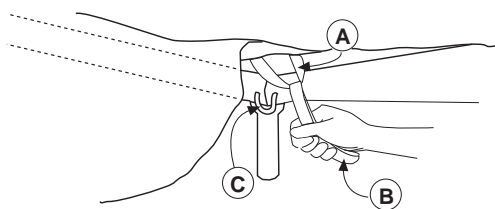

- Attach one corner of the Tent Top to the frame by pulling handle **(B)** to place loop webbing **(A)** under the corner loop **(C)**.

Step 9B

ATTACHING THE LAST

- Attach as in 9A. If tight, insert a stake through webbing **(A)** and press down and under until the webbing slips under the corner loop **(C)**.

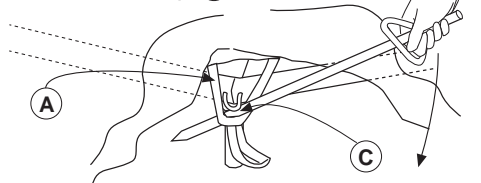

Step 10

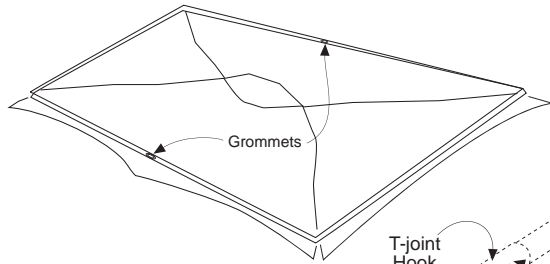

- Insert each T-Plus hook through corresponding grommet on the Tent Top.
- Temporarily hold in place with S-hook of the tension strap.

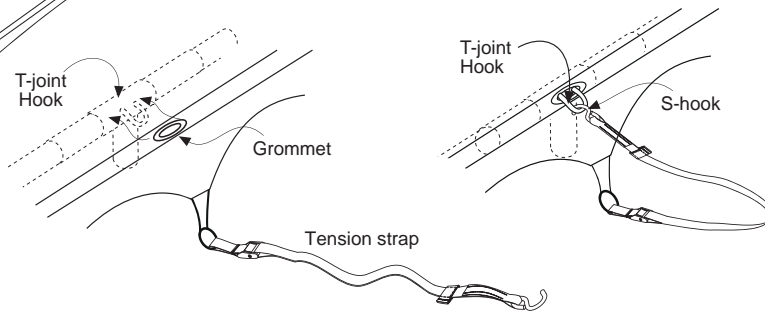

ERECTING THE TENT

Step 11

INSTALLING POSTS

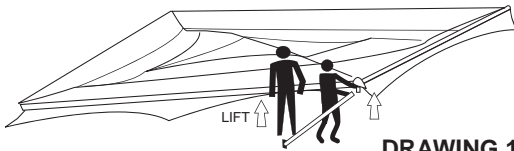

DRAWING 11:1

- To install the first Post, lift one corner and slide the Post into the Corner sleeve.
SEE DRAWING 11:1

- Lock post in place using lock-pins ↓↓

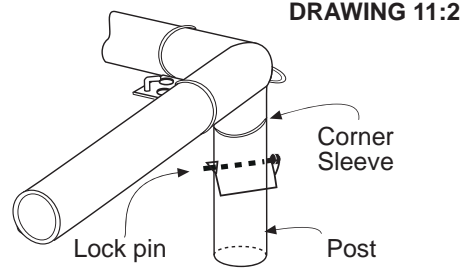

DRAWING 11:2

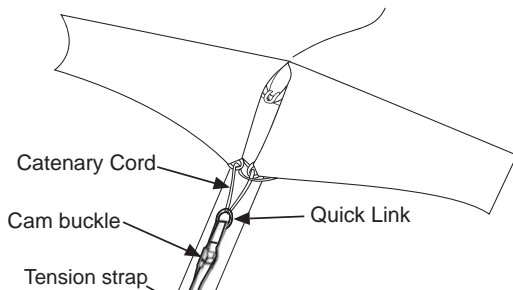

DRAWING 11:3

- Insert s-hook at the bottom of the tension strap into the hole in the Base. SEE DRAWING 11:3
- Tension strap by pulling the strap down.
- Repeating the same procedure, install 2nd corner post, followed by the side posts of the same side.

IMPORTANT!
 Legs must move inward as other legs are raised.

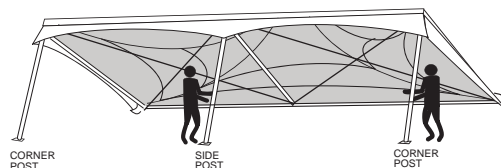

DRAWING 11:4

Step 12

CENTREPOLE INSTALLATION

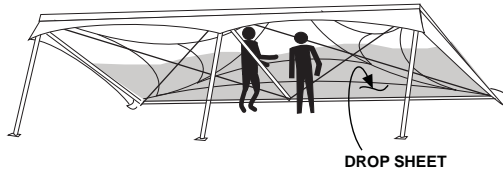

- After raising one side, move Drop Sheet towards the lower half of the frame to expose the Cable intersection.

Step 13

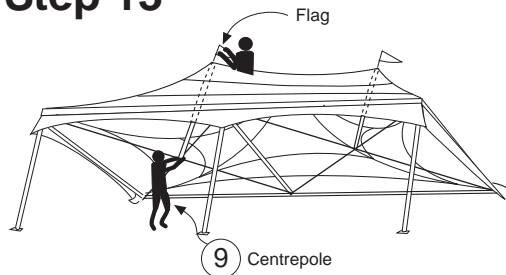

- Insert the Centrepole (9) through the centre socket of the Tent Top.
- Install the Flag on the Centrepole

*** If one must step on fabric, remove shoes to avoid soiling or damaging the Tent Top.**

Step 14

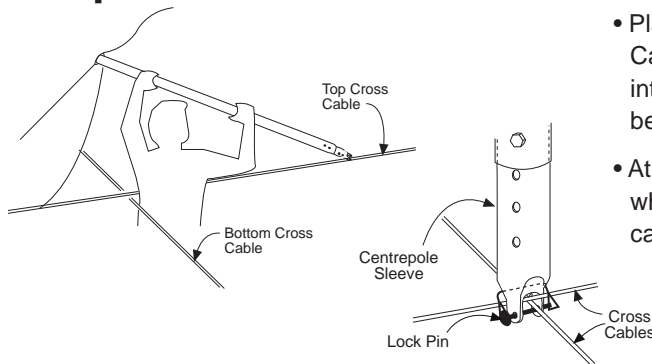

- Place the Centrepole lower end on the top Cable and slide it toward the Cross Cable intersection, wedging the Centrepole between the cover and the cables.
- At the intersection, push down bottom cable while pulling up the top cable to set both cables directly below the Centrepole sleeve.
- Secure the Centrepole to the cables using the Lock-Pin.

Step 15

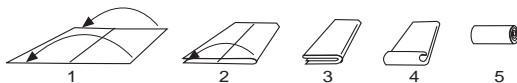

- Remove Drop Sheet and fold keeping clean side in.

Step 16

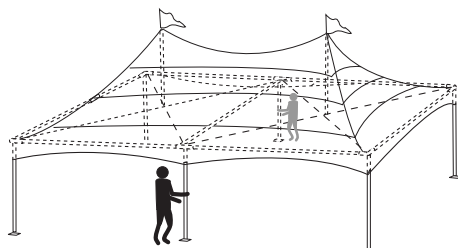

- Install the remaining Posts, inserting the Corner Posts first and then the Side Post.

- Lock Posts in place using the Lock-Pins (10).

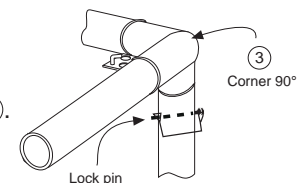

Step 17

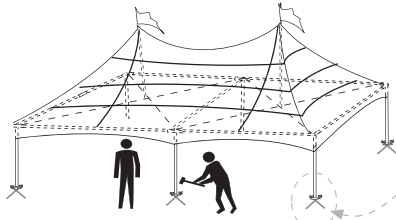

- Straighten Posts and drive Stakes (10) at each Post Base.

IMPORTANT

Each installation site must be evaluated by installer to determine proper securing method. Site conditions may require guying and anchorage different from what was provided with the tent.

Step 18 — SECURING TENSION STRAPS

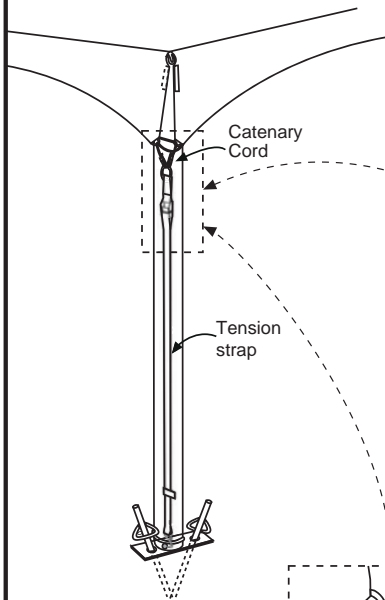

- Tension the Tent Top by tightening each tension strap. Tie off slack rope tails to main ropes.**

Catenary cord assembly detail:



D-rings should overlap once tension strap is tensioned.



IMPORTANT: Each installation site must be evaluated by installer to determine proper securing method. Site conditions may require anchorage different from what was provided with the structure.

Summary

1. Check parts.
2. Assemble Corner 90°, 9' 3" and 5' Eve Tubes, T-plus and Midjoints to form upper frame.
3. Install Cross Cables.
4. Spread Drop Sheet over Cross Cables to protect the Tent Top.
5. Unfold Tent Top.
6. Attach Tent Top webbings to corner loops.
7. Insert T-joint hooks through grommets. Temporarily secure with S-hook.
8. Install Posts. Secure with Lock-Pin and insert the s-hook of the toggle rope into the hole in the Post Base.
9. Move Drop Sheet to clear the Cross Cable intersection area.
10. Insert Centrepole through the centre socket.
11. Install Flag from outside.
12. Slide Centrepole over the Cross Cable intersecting point.
13. Remove and fold Drop Sheet.
14. Install remaining Posts.
15. Drive Stakes through each Post Base.
16. Tension each toggle rope.
17. Install Guy Ropes, Walls, Joiners.
18. Make final inspection to ensure everything is in operational condition.
19. Clean up site.

To take down the tent, reverse the preceding installation steps.

Guy Rope Installation

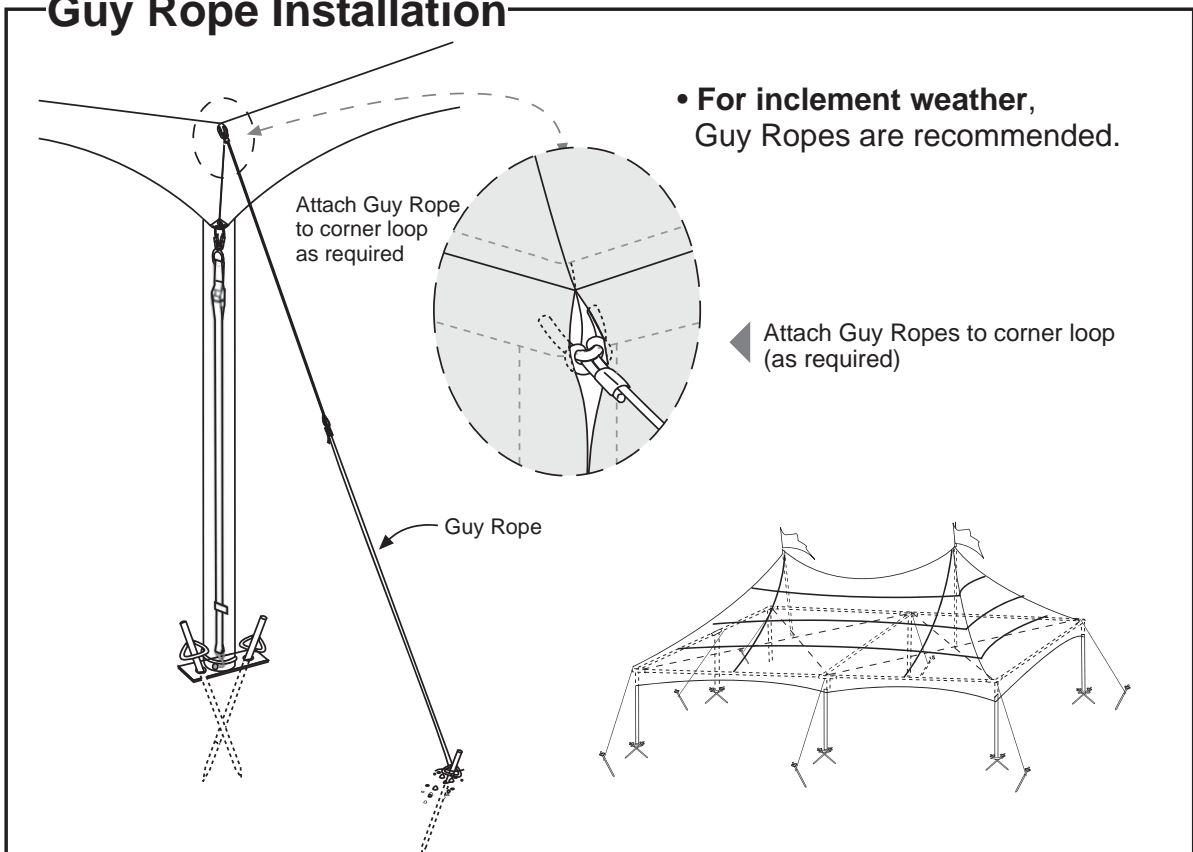

Wall Installation

* Before installing walls, make sure toggle ropes are evenly tensioned and the Tent Top is evenly positioned on the frame.

Check that Cable for Slide Wall is properly tensioned. Tighten with turnbuckle if needed.

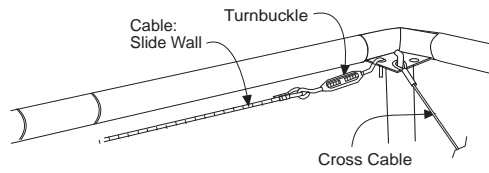

1. Clip walls to Cable.

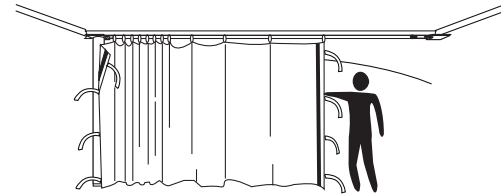
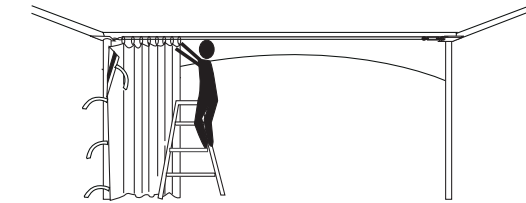
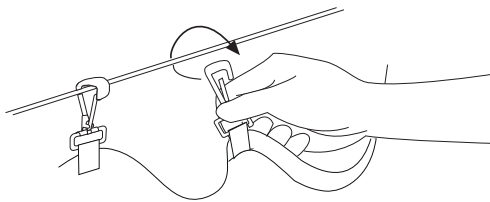

2. Secure side wall straps to Posts. =>

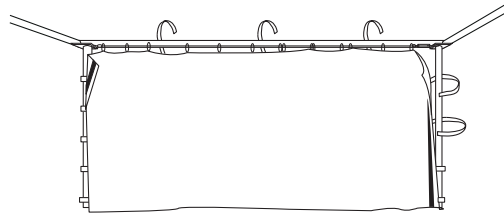

3. Secure top wall strap to Eve Tube.

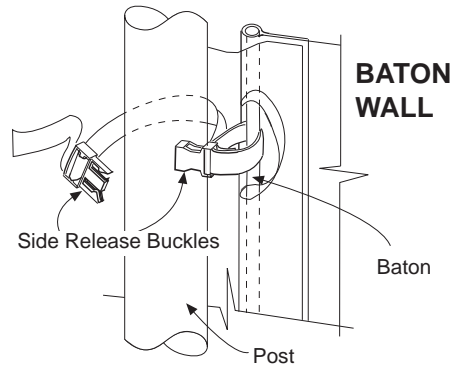
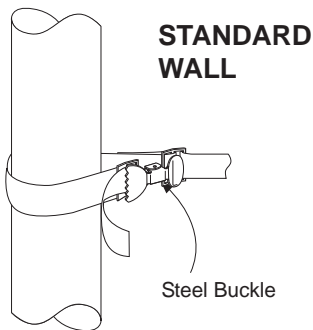

4. If two or more walls are installed, fasten velcro strips on the edges of the walls for a wind proof seam.

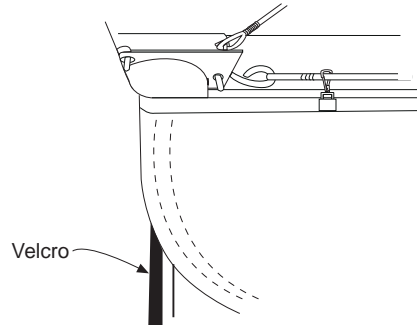
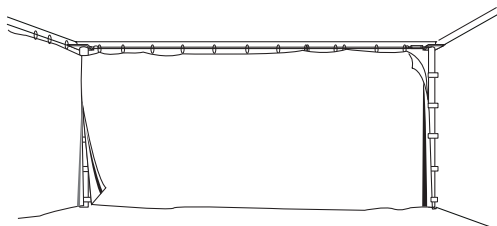

Care for your Vinyl Tops

Care for your vinyl tops as you would to any vinyl surface.

Use mild detergent industrial cleaner with no chlorox.

To clean, spread tent top on clean surface. Try laying fabric on astro turf to wash. Dirt and tiny sharp particles tend to fall into the carpet pile, away from the fabric. Some renters set up the tents to wash and dry.

Spray detergent solution onto fabric. Use more concentrated solution on soiled areas.

Rub, scrub or brush; elbow grease is an essential ingredient. Pressure washing may harm your tent fabric and is not recommended. Rinse with clean water, hang cover and allow to dry thoroughly.

DO NOT put your tent away damp. Mold & mildew will grow and discolour the cover. Always dry the tent. To speed things up, try fans or carpet air blowers and hanging the canopy.

Trees can be a problem with sap, pollen, etc. Flowers & leaves, sometimes contain powerful natural organic chemicals capable of staining your beautiful tent. Beware of tents under trees!

- Always use a drop sheet during setup and take down.
- Have some cleaning equipment with you for on-site clean ups.
- Besides being a fire hazard, BBQ's add a lot of grease and grime to the underside of the tent and are not recommended even with the walls off.

STORAGE - store vinyl canopies and other parts **clean** and **dry**.

Maintaining Your Tent

Your **WSSL Peak Marquee Tent** will serve your needs now and for many years to come. Tighten the top and walls to avoid wind flap and consequent wear on the fabric. Periodically the fabric should be cleaned; in place or when dismantled. Using mild detergent, water and a deck mop, clean wipe the fabric roof or walls. Let dry. Repair any damage to the fabric using a WSSL Fabric Repair Kit. Repair or replace any possible damaged frame parts.

TENT FABRIC CHARACTERISTICS

MILDEW - If mildew is detected, remove it immediately. Regardless of treatment, there is no way to absolutely stop fungus growth if it is prevalent in your area. No tent can be guaranteed not to mildew. Vinyl fabrics may mildew in storage if not properly stored. **BE SURE TENT IS CLEAN AND DRY BEFORE STORING IN A COOL, DRY PLACE.**

WATER RESISTANCE - WSSL tents are made of waterproof vinyl/polyester fabrics using waterproof welded seams. Because these fabrics are impervious to moisture, condensation may occur with some heaters and if the tent is poorly vented. Do not confuse water condensation with leakage especially on vinyl tents.

FLAME RESISTANT - All WSSL tent tops and walls are fire retardant. All WSSL tent fabrics satisfy ULC-S109, NFPA 701, and California fire marshal tests for fire resistance.

FADING-OPACITY - Variable sun conditions, exposures, types of materials and fabric finishes all influence the weathering of fabrics. WSSL fabrics have been chosen for their colour and opacity consistency and stability.

COLD CRACK - Chosen for their tolerance to cold cracking, our translucent fabrics remain flexible at temperatures below 0°F. The opaque fabrics are laminated and therefore become stiffer as the temperature drops. When the temperature is near 32°F, care should be taken in folding and moving the fabric to prevent cracking of the vinyl, especially the walls with windows.

Notes

Notes

Notes

A large, empty rectangular box with a thin black border, intended for the user to write notes. It occupies the majority of the page's vertical space.

WSSL TENTS

Warner Shelter Systems Limited creates fabric-clad structures to suit virtually every purpose, from special events, trade shows, catering and outdoor concerts to warehousing and industrial use. Our award-winning tents are user-friendly, durable and set-up quickly.

We have earned a reputation for providing a high level of service to customers since 1970. It is a pleasure to serve you. Please contact us for further information.



PEAK MARQUEE TENT

A favorite for special events, fairs, trade shows, and food service use. With its ease of setup and lightweight frame, the Marquee is user-friendly as well as attractive.

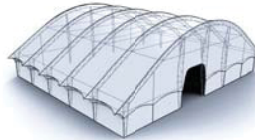

MODULAR CLEARSPAN BUILDING

Modular building Often used for large special events, but are equally suitable for warehousing, retail and industrial use and environmental projects. "MODS" are spacious and strongly built.



PEAK POLE TENT

Great Solution for large functions of all types, combining the nostalgic appeal of old fashioned circus "big tops" with the advantages of modern technology. Available in 40', 60', 80', and 90' widths.



ARABESQUE THEATRE TENT

The Arabesque Theatre with its high arched ends allows generous height over a stage at one end and bleacher seating at the other. These tents singularly or joined together, create a large attractive, clearspan interior.

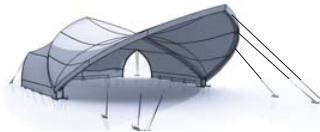

ARABESQUE STAGECOVER

The Arabesque Stagecover creates a striking backdrop for any outdoor concert with its dramatic curves and bold stripes. It is renowned for its superb acoustic projection and excellent sight lines.



DOMESTAGECOVER

With great acoustics and excellent sight lines, our attractive SC series is available in four sizes, with the SC-70A large enough to accommodate a full orchestra.

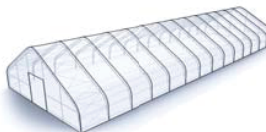

WSSL GIGA-SPAN

The WSSL Clearspan Series structures are designed, engineered, and manufactured in our CWB certified plant. The open web truss galvanized steel frames are assembled to satisfy the applicable building code.



TENT -C- CAN

The WSSL Tent -C- Can: For its 40 years anniversary Warner Shelter Systems Limited WSSL offers to the world with a NEW Warner Innovation.



WSSL GARAGE

WSSL Garage come complete with galvanized steel frame and fire retardant cover, easy to relocate structure featuring clear span truss framing, and 12' x 12' sliding door for easy access.



TENT-X-SPAN

Sturdy, versatile and portable, the Tent-X-Span fabric structures are light weight, easy to transport, store, and erect. Box beam aluminum frame, interchangeable parts, and easily joins to peak marquee tents.

Copyright © 2010 by Warner Shelter Systems Limited
All rights reserved.

This manual or any part thereof must not be reproduced in any form without the written permission of Warner Shelter Systems Limited.

The information contained in this manual is intended for the exclusive use of the customer and/or Building Authority.

Warner Shelter Systems Limited is not responsible for personal injury and damage to property caused by the application of the procedures documented in this manual to any situation not explicitly contemplated here.



Warner Shelter Systems Limited

Tents and Fabric-Clad Structures

9811 - 44th Street, SE, Calgary, Alberta, Canada T2C 2P7
Phone: (403) 279-7662 or (800) 661-6155; Fax: (403) 236-2633
Website: www.wssl.com • E-mail: warner@wssl.com