

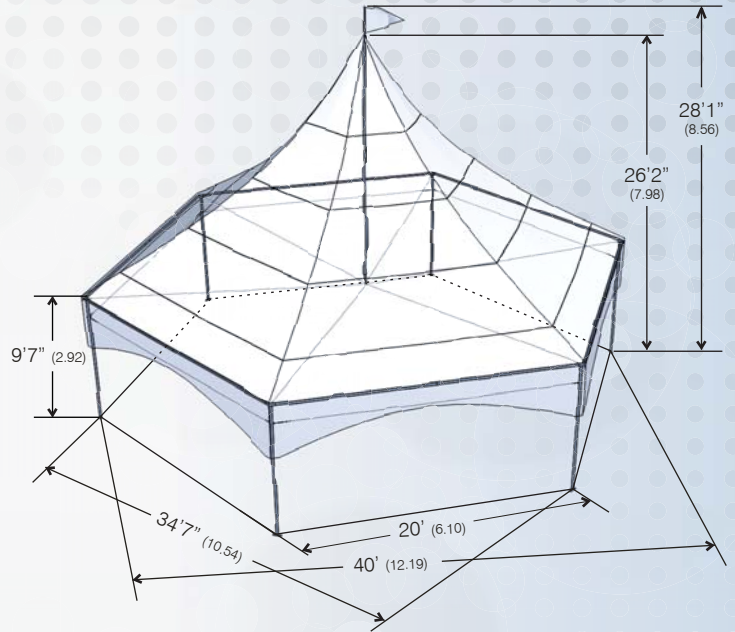

Tents for your Events

PEAK MARQUEE TENTS MQ34HEX



TOTAL AREA: 1043 sq. ft. / 96.9 sq. m.



EASY ASSEMBLY AND SETUP

The *Peak Marquee* Tents require very little manpower to setup or take down. Comprehensive, easy to follow instructions are sent with each tent.

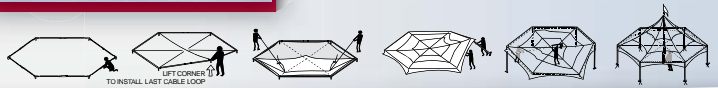



PEAK MARQUEE MQ34HEX

PEAK MARQUEE TENT FEATURES

EASY SETUP

This tent can be set up easily by 2 people.

TOUGH

Smooth graceful roof lines conceal a rental tough, durable, simple frame.

INTERCHANGEABLE PARTS

Through nine sizes from 100 to 1043 sq.ft. streamlining rental inventory.

FULL MODULARITY

Unique gutter system allows the tents to be joined in a variety of configurations.

POLE FREE INTERIOR

Flying Centre Pole gives an obstruction free spacious interior.

WALLS SLIDE OPEN AND CLOSED

Walls remain clean, with less wear and tear.

The WSSL PEAK MARQUEE TENTS

*Elegant, Dramatic,
Beautiful,*

STRONG & STABLE



Designed and Engineered in 1984 by Kurt Warner P.Eng.

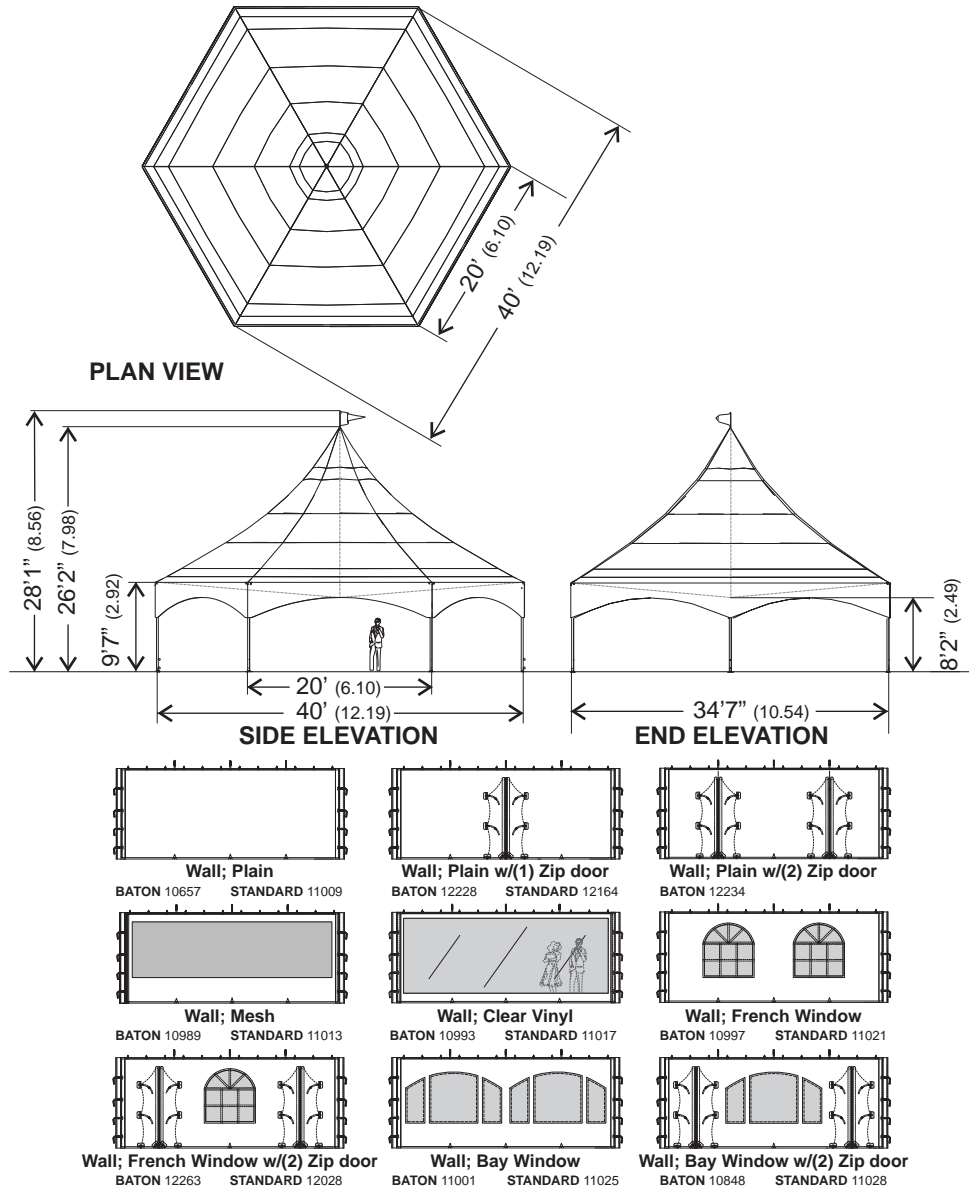

MQ34HEX SEATING SUGGESTIONS

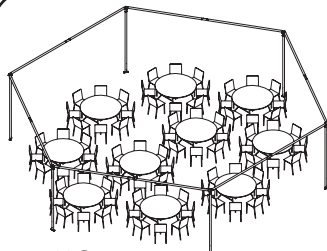

80 Persons
13 sqf per person

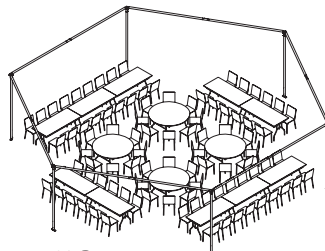

92 Persons
11.3 sqf per person

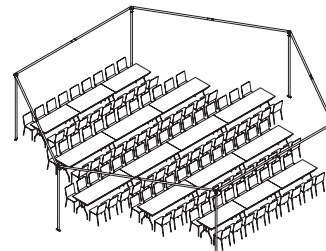

98 Persons
10.6 sqf per person

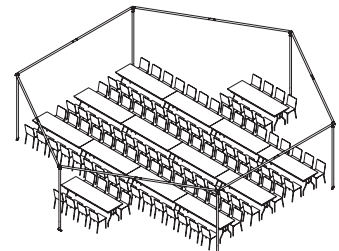

112 Persons
9.3 sqf per person