



MQ34 HEX

PEAK MARQUEE TENT

ASSEMBLY INSTRUCTIONS

IMPORTANT:

PLEASE READ INSTRUCTIONS PRIOR TO ERECTING THE TENT.

PROPER INSTALLATION WILL ENSURE MAXIMUM USAGE AND STABILITY OF THIS STRUCTURE.

IF FURTHER INFORMATION OR CLARIFICATION OF ANY PART OF THE ENCLOSED INSTRUCTION IS REQUIRED, PLEASE CONTACT:

WARNER SHELTER SYSTEMS LIMITED
1-800-661-6155 OR E-MAIL: warner@wssl.com

CAUTION

1. Each installation site must be evaluated and the proper securing method determined by the installer. Some soils require staking or securing different from that which was provided with the tent.
2. Good judgment and common sense must be used along with installation guidelines. It is the responsibility of the tent installer/maintainer to anticipate the severity of the weather along with the proper time and method of setup and take down. Evacuation of the tent is recommended before weather becomes extreme. A successful event is a safe event.
3. Proper safety equipment, such as hard hats, steel toe shoes, and safety glasses, should be used to ensure a safe setup and take down.

Table of Contents		PAGES
1.)	TENT LOCATION	2
2.)	PARTS LIST AND PARTS NUMBER	3
3.)	FRAME ASSEMBLY	4 - 5
	Post & Centrepole Assembly Step 2 - 3 PAGE	4
	Upper Frame Assembly Step 4..... PAGE	4
	Cross Cable Installation Step 5 - 6 PAGE	5
4.)	TENT TOP INSTALLATION	5 - 7
	Protecting Tent Top Step 7..... PAGE	5
	Unfolding Tent Top Step 8 PAGE	6
	Securing Tent Top to Frame Step 8A/8B PAGE	7
5.)	ERECTING THE TENT	7
	Installing Posts Step 9 PAGE	7
	Installing Centrepole Step 10 - 15 PAGE	8 - 9
	Securing the Structure Step 14 & 16 PAGE	9 - 10
6.)	WALL INSTALLATION.....	11
7.)	JOINER INSTALLATION	12 - 13
8.)	SUMMARY	13
9.)	CARE FOR YOUR VINYL TOPS	14
10.)	MAINTENANCE	14

Tent Location

VERY IMPORTANT!

Ascertain tops, guys, and other tent parts are in good operating condition. Any components showing damage should be replaced immediately.

Before unloading, review the proposed location of the tent. In doing so, take into account the following:

- Hazards** Locate, mark, and avoid any overhead or underground electrical, phone, gas, sprinkler or other lines. Take note and always be aware of any and all hazards. **DO NOT BEGIN ANY ASSEMBLY UNTIL THE HAZARDS HAVE BEEN MARKED AND CAN BE SAFELY AVOIDED.**
- Access** Plan the best route for bringing the tent and equipment for the setup onto and off the site.
- Drainage** Attempt to influence the location of the tent so that rain or melting snow can drain away.
- Obstacles** A clean, level and unobstructed site will provide an easy assembly of the tents.
- Weather** Do not attempt to setup the tent during thunderstorms, high winds or other extreme conditions.
- Safety** Before the set up, instruct the crew on safety procedures. All local safety and fire regulations must be followed.

ALL SITE PERSONNEL MUST FOLLOW OCCUPATIONAL HEALTH AND SAFETY PROCEDURES.

MQ34 HEX PEAK MARQUEE TENT

CAUTION: Tension straps must be maintained tight and even for proper tensioning of the canopy fabric. The fabric must remain taut to avoid rain ponding.

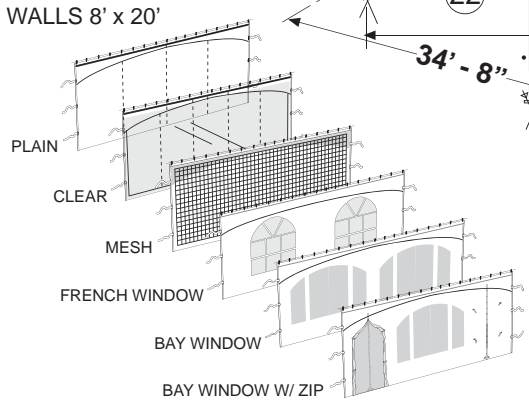
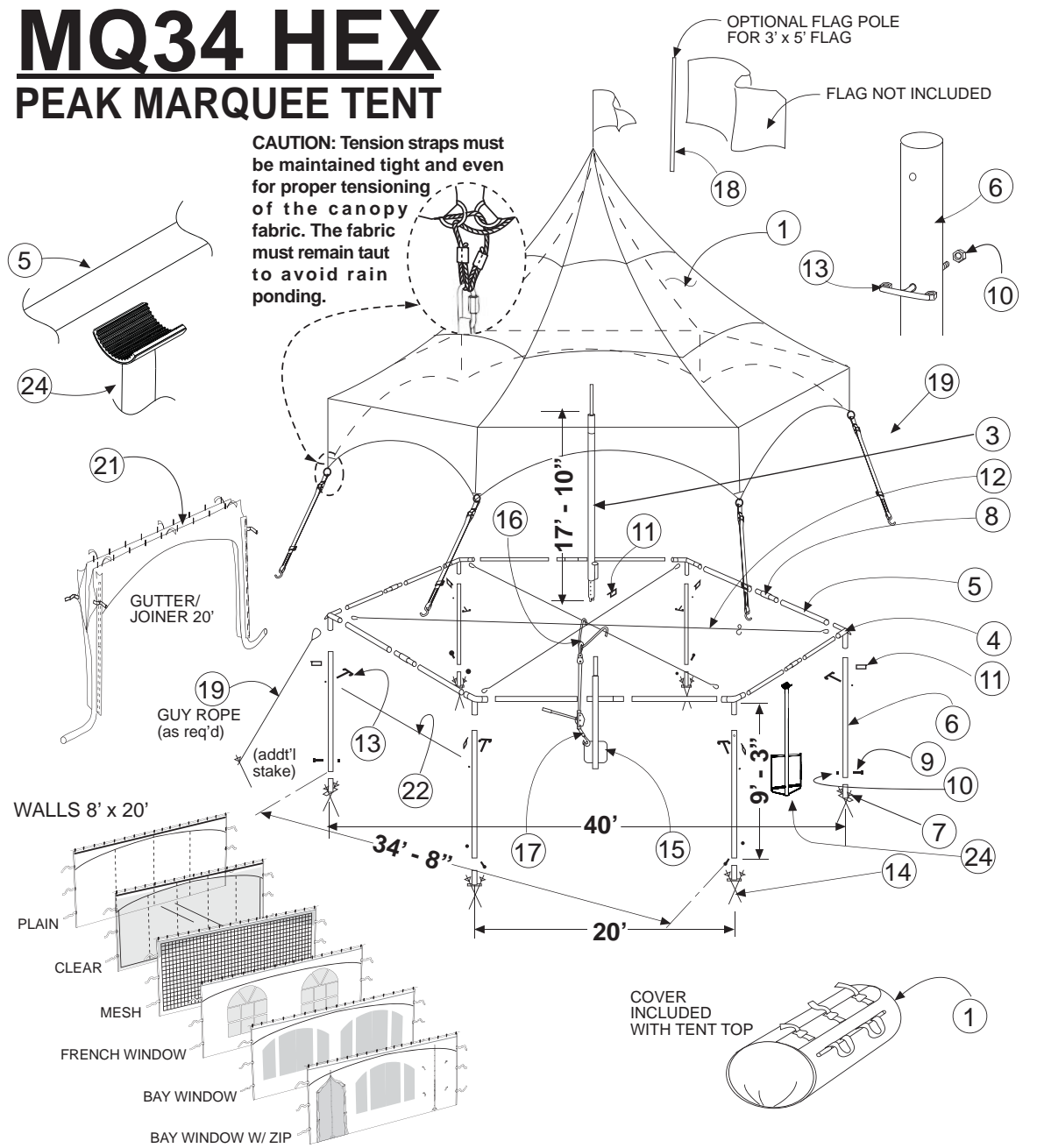

OPTIONS

	ITEM	PART	QTY	PART NO.
FRAME	(3)	CENTREPOLE	1	10521
	(4)	CORNER 120°	6	10627
	(5)	EVE TUBE 9' - 3" (Steel)	12	7161
	(6)	POST 9' - 3" (Steel)	6	10592
	(7)	BASE; MQ FLAT	6	10514
	(8)	MIDJOINT (Steel)	6	7284
	(9)	BOLT 5/16" - 3" NC	6	4093
	(10)	NUT 5/16; NYLOK	6	8369
	(11)	LOCK PIN	7	7843
	(12)	CROSS CABLE	3	7340
	(13)	BRACKET SLIDE WALL	6	10655
	(1)	TENT TOP, HEX 34 REG.	1	10625

	ITEM	PART	QTY	DESCRIPTION	
OPTIONS	(14)	STAKE 3/4" X 34"	18	10666	
	(15)	TOOL; CENTREPOLE	1	10324	
	(16)	TOOL; CABLE	1	10325	
	(17)	TOOL; PULLER*			
	(PULLER AVAILABLE FROM YOUR LOCAL HARDWARE STORE)				
	(18)	FLAG POLE EXT.	1	9523	
	(19)	GUY ROPE	as req'd	10689	
	(20)	DROP SHEET	1	10634	
	(21)	GUTTER/JOINER 20'	as req'd	10959	
	(22)	CABLE: SLIDE WALL 20'	as req'd	10673	
	(23)	BASE; MQ ADJ. 24"	6	11064	STEEL
(24)	LIFT EASY	1	11065		

Step 1

- Check all the parts before assembling the tent.
- Refer to assembly drawing on page 3 for part quantities and part numbers.

* Bolts, Nut and Lock-pins not shown.

PRE ASSEMBLY

Step 2

- Assemble the Post 9'-3" (6) with the Base (7) using Bolts (9) and Nuts (10).

Step 3

- Assemble the Centrepole (3) using the same type of Bolts and Nuts.

CENTREPOLE ASSEMBLY
STEEL (PART# 10521)

FRAME ASSEMBLY

Step 4

- Assemble perimeter frame.
- Assemble Corner 120° (4), Eve Tubes (5) Midjoints (8), by slipping one tube to another to form upper frame.

CROSS CABLE INSTALLATION

Step 5

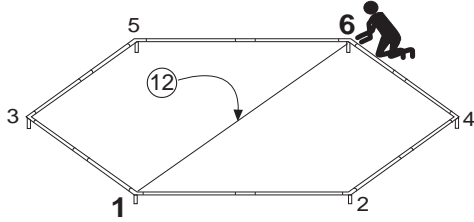

NOTE: The corners are numbered for convenience of explanation only.

- Install first Cross Cables (12) from corners 1 to 6 by hooking the cable end loop over the corner pin.

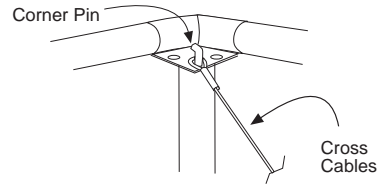
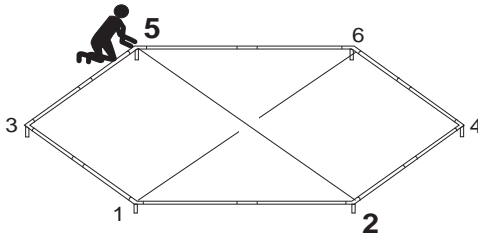

- Install second Cross Cable to corners 2 & 5.
- Install 3rd cable to corners 3 & 4 above other two cables. Lift either corner to shorten the distance and easily hook the cable in place.

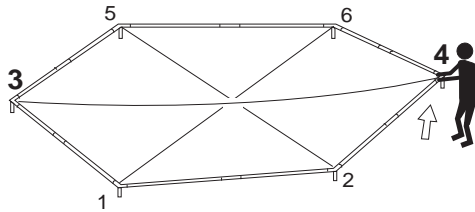

Step 6

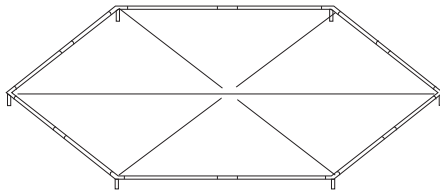

- Lowering the corner causes the corners to adjust their position and the cables to tighten.

TENT TOP INSTALLATION

Step 7

PROTECTING TENT TOP

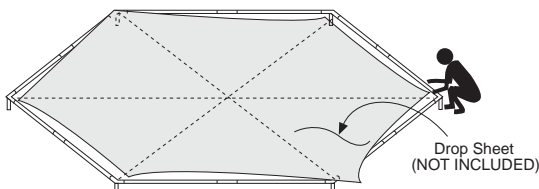

- Unfold Drop Sheet (not included) (20) over the Cross Cables to protect the Tent Top and to keep the Tent Top clean.

ERECTING THE TENT

Step 8

UNFOLDING TENT TOP

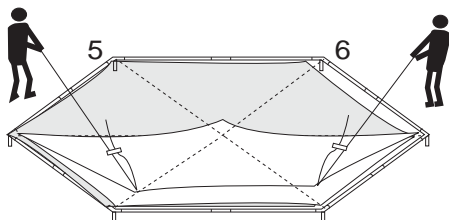
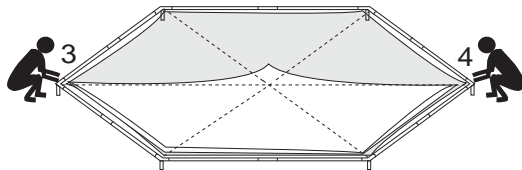
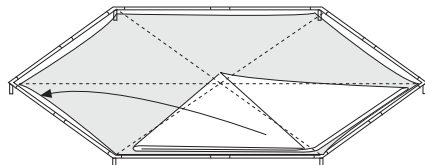
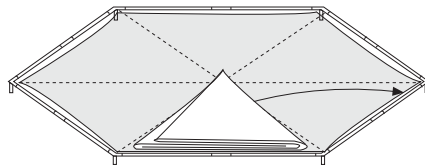
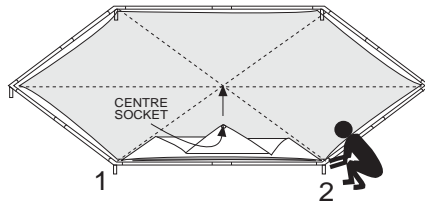
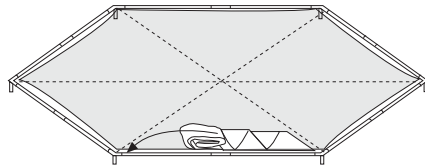
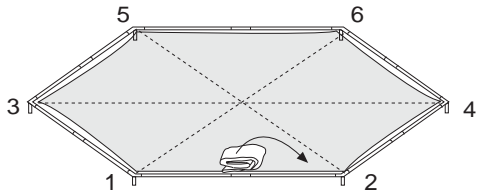

NOTE: The corners are numbered for convenience of explanation only.

- Place the Tent Top beside the mid joint of one frame section and unfold the fabric along one edge.

Ensure that centre socket would pull out towards the centre, otherwise rotate entire Tent Top bundle 180°.

- Pull centre socket, unfolding towards the centre.
- Attach webbings 1 & 2 to corresponding corners as shown in **STEP 8A** on **PAGE 7**.

- Pull the upper layer of the Tent Top toward the adjacent frame section.

- Pull the next upper layer of the Tent Top to the opposite frame section.

- Attach webbings 3 & 4 to corresponding corners. **SEE STEP 8A.**

- To unfold the remaining half of the Tent Top, use two of the toggle ropes attached to the Tent Top and pull toward opposite side.

- Attach webbings 5 & 6. To attach last webbing, **SEE STEP 8B** on **PAGE 7**.

- Ensure all 6 webbings are properly attached to corresponding hooks of each corner.

ATTACHING WEBBING TO CORNER HOOK

Step 8A

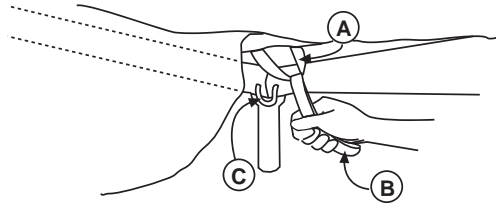

- Attach one corner of the Tent Top to the frame by pulling handle (B) to place loop webbing (A) under the corner loop (C).

Step 8B

ATTACHING THE LAST

- Attach as in 8A, but if tight, insert a stake through webbing (A) and press down and under until the webbing slips under the corner loop (C).

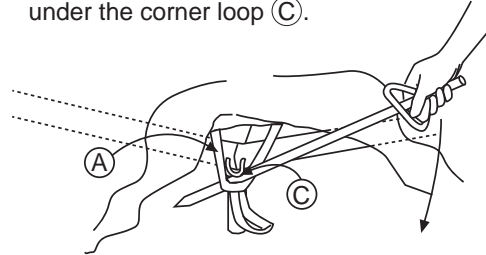

ERECTING THE TENT

Step 9

INSTALLING POSTS

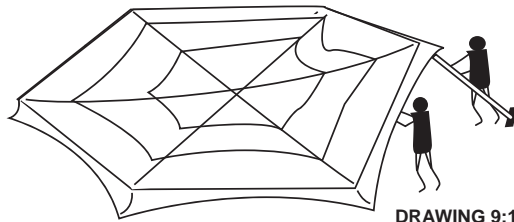

- To install the first Post, lift one corner and slide the Post on the Corner sleeve. SEE 9:1

- Lock post in place using Lock-pins. =>

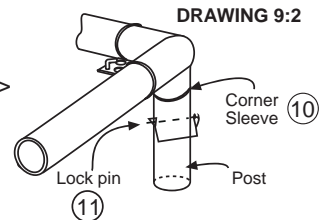

- Insert s-hook at the bottom of the tension strap into the hole in the Base. SEE DRAWING 9:3
- Tension strap by pulling the strap down.
- Repeat the procedure for the adjacent 2 posts.

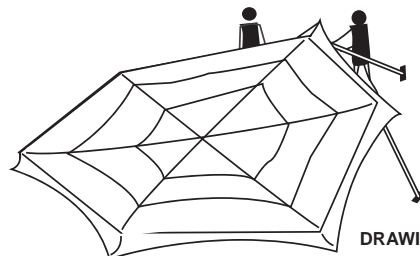
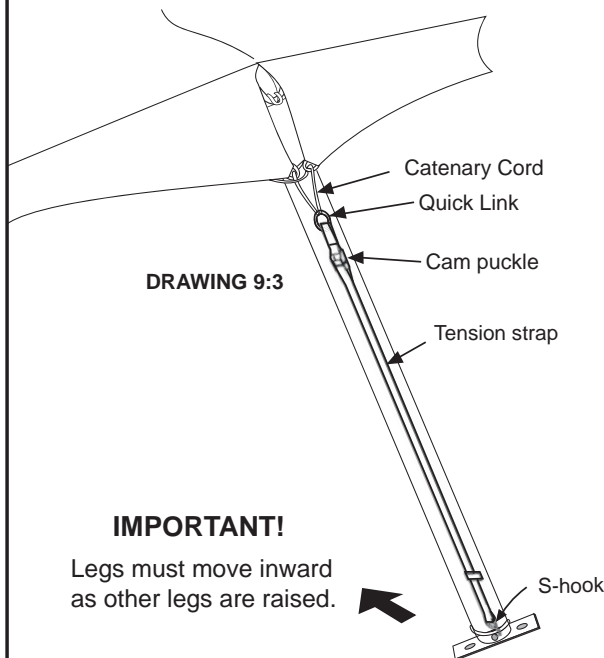

Step 10

CENTREPOLE INSTALLATION

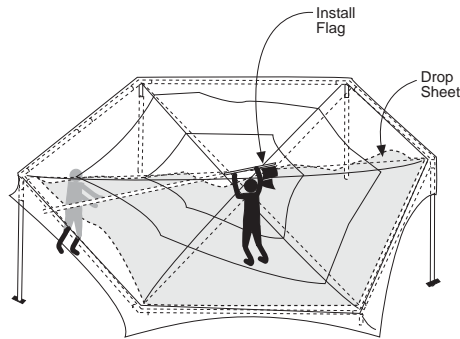

- Push Drop Sheet to the lower half of the frame to expose the Cable intersection.
- Insert the Centrepole ③ through the socket at the centre of the Tent Top and lean the Centrepole against the intersection of the Cross Cable.
- Install the Flag on the Centrepole from the outside.

*** Be careful when stepping on Tent Top. Removing shoes or using soft shoes is recommended to avoid soiling or damaging the Tent Top**

Step 11

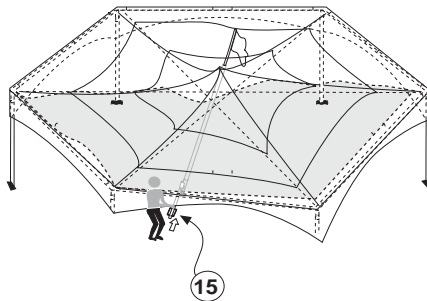

IMPORTANT!

Adjust centrepole sleeve up or down.
Centrepole must be long enough to create taut cover.

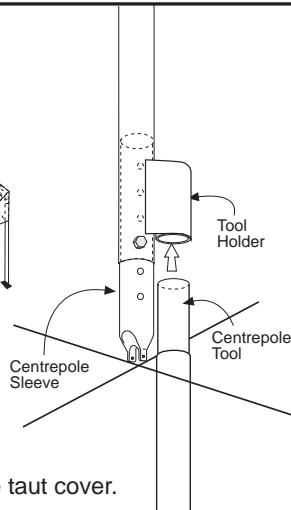

- Slide the Centrepole Tool ⑮ into the tool holder located at the bottom of the Centrepole.
- Move Centrepole with the tool holder to a nearly vertical position and let stand on the ground

Step 12

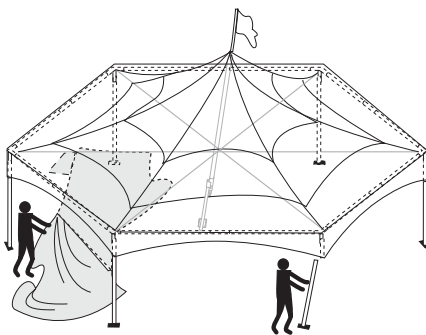

- Install the remaining Posts using the same procedure as explained in Step 9.
- Remove and fold Drop Sheet keeping clean side in.

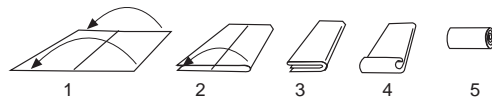

Step 13

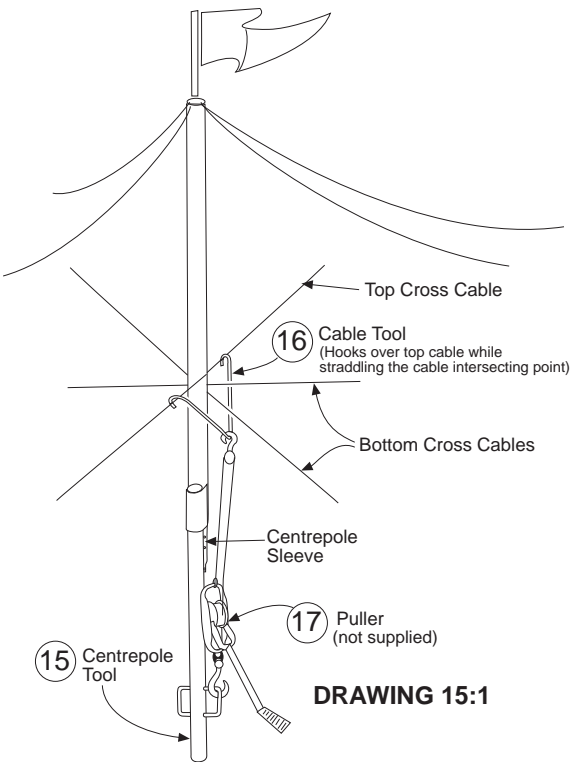

DRAWING 15:1

- Attach the Cable Tool (16) to the top Cross Cable. SEE DRAWING 15:1
- Attach a 1 TON Puller (17) to the Cable Tool and the other end to the handle of the Centrepole Tool (15).
- Raise the Centrepole by cranking the Puller until the bottom of the Centrepole Sleeve is slightly above the Cables. SEE DRAWING 15:2

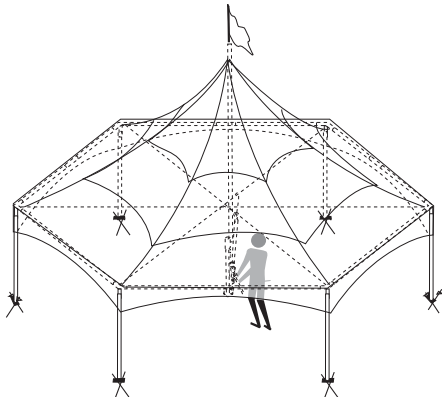

DRAWING 15:2

DRAWING 15:3

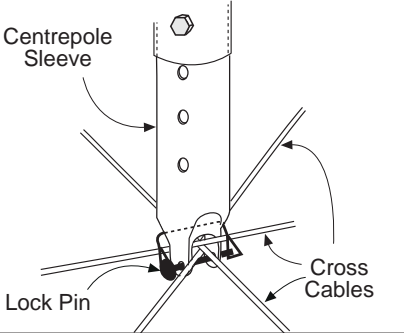

- Align the Centrepole Sleeve and lower it over the intersecting point of the three Cables. <= SEE DRAWING 15:3
- Secure the Centrepole to the Cables using the Lock Pin.
- Remove the Cable Tool and Puller.

Step 14

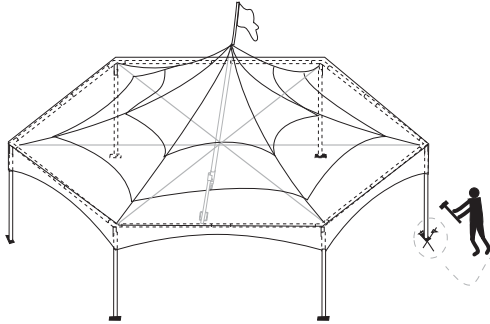

- Straighten Posts and drive two Stakes (14) at each Post Base.

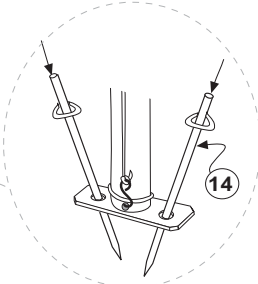

NOTE: If the weather will allow, it may be more convenient to stake the bases after raising the Centrepole.

Step 15

SECURING TENSION STRAPS

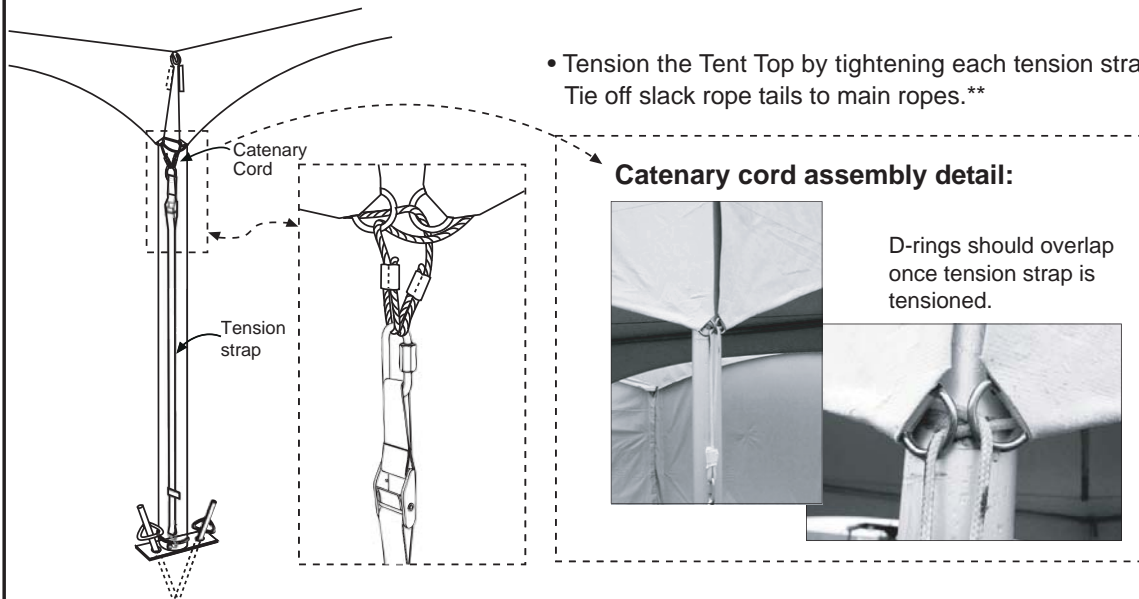

IMPORTANT: Each installation site must be evaluated by installer to determine proper securing method. Site conditions may require anchorage different from what was provided with the Tent.

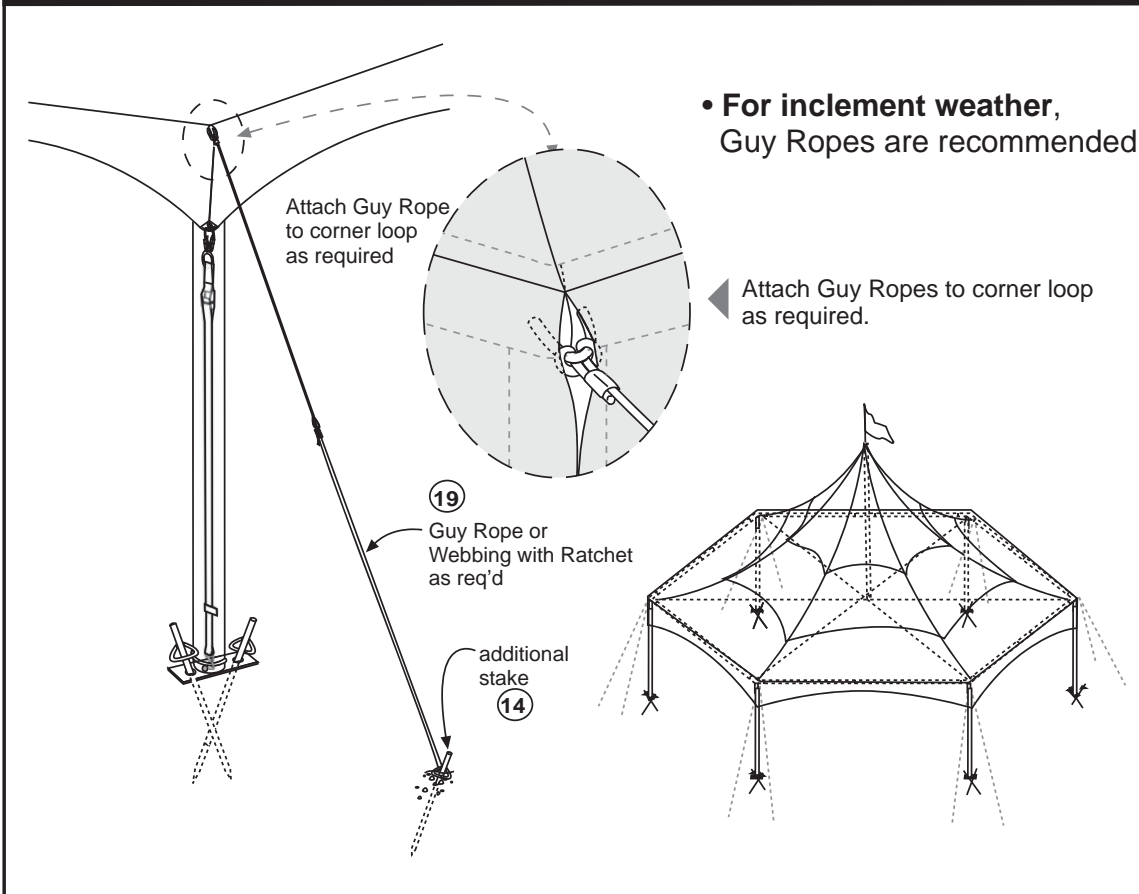

Wall Installation

* Before installing walls, make sure toggle ropes are evenly tensioned and the Tent Top is evenly positioned on the frame.

Check that Cable for Slide Wall is properly tensioned. Tighten with turnbuckle if needed.

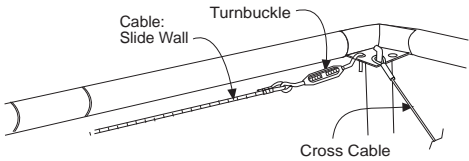

1. Clip walls to Cable.

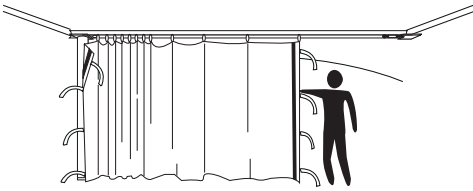
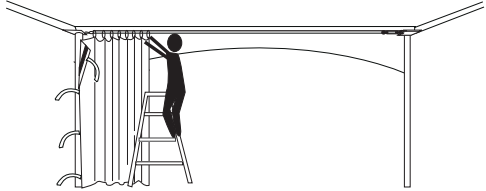
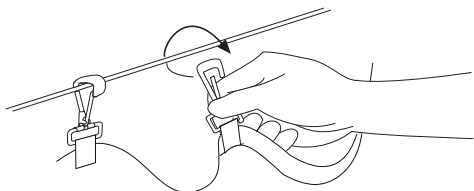

2. Secure side wall straps to Posts. =>

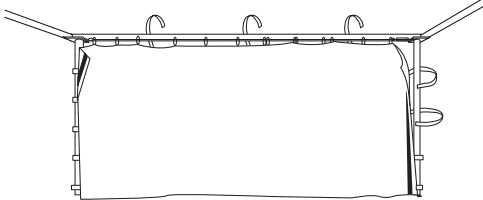

3. Secure top wall strap to Eve Tube.

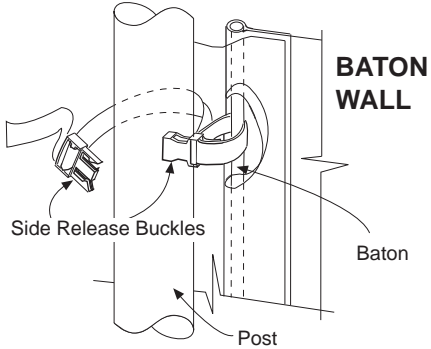
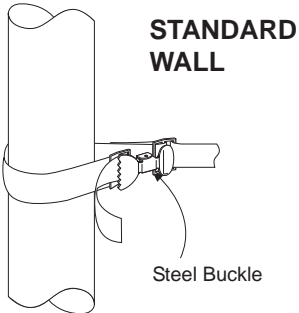

4. If two or more walls are installed, fasten velcro strips on the edges of the walls for a wind proof seam.

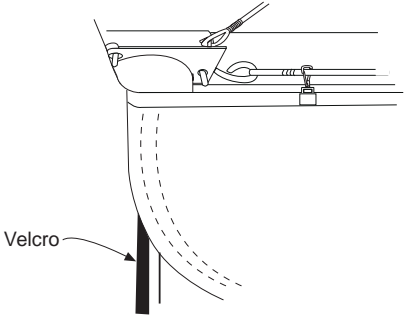
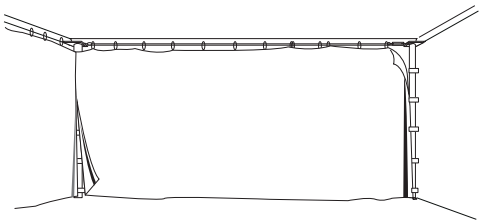

Joiner Installation

1. Unfold joiner
2. Attach velcro straps to Eve Tube while tensioning toward corners.

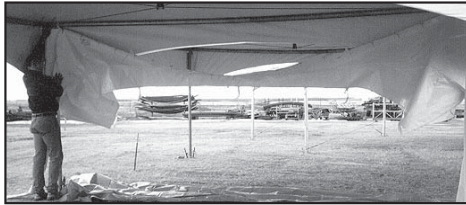
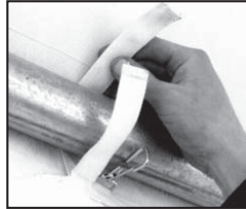

3. Attach clips to Cable: Slide Wall.

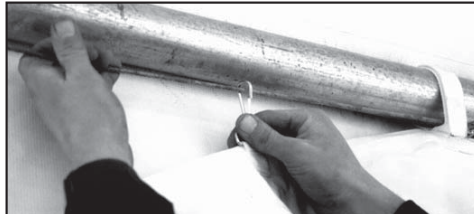

4. Repeat procedure on the opposite side.



5. Insert lapels between two posts

(* Loosen toggle ropes to slip lapels underneath it.)

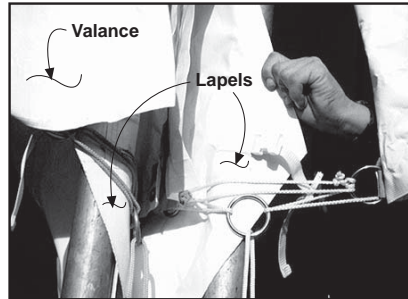

6. Spread lapels under valance.

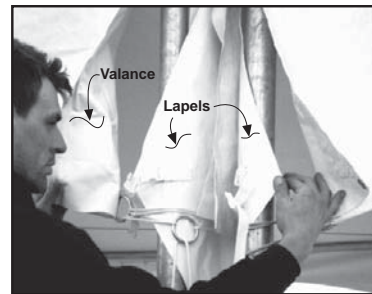

7. Insert the strap on the lapel through the ring in the adjacent valance and secure buckles. Pull loose strap to tighten.

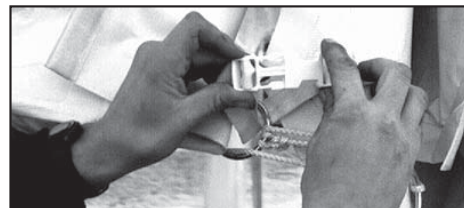
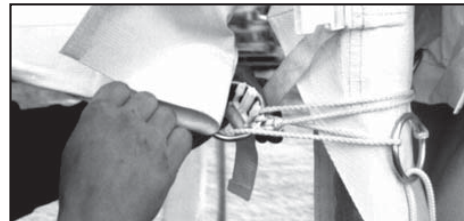

8. Fix downspout and tension toggle rope.

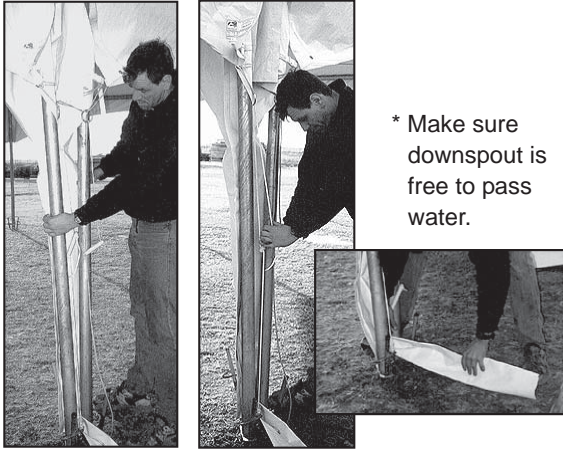

* Make sure downspout is free to pass water.

10. From inside, fasten joiner and wall velcro together to hide posts.

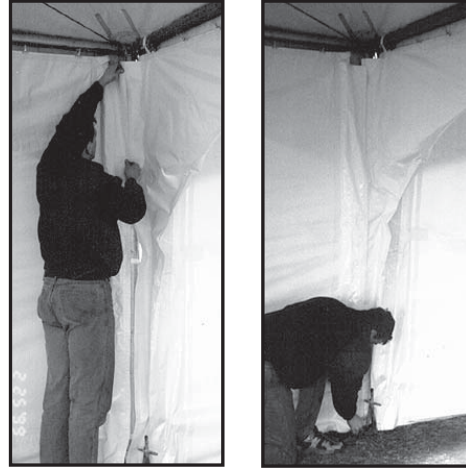

9. Fasten Tent Top velcros from top to bottom over the lapel. Flatten well for a neat seal. =>

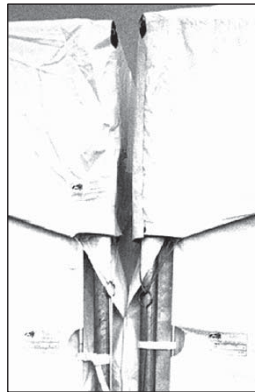

<= Correctly installed joiner.

11. Joiner should smoothly follow the catenary curve.



Summary

1. Check parts.
2. Assemble Corner 120°, Eve Tubes, Midjoints to form upper frame.
3. Install Cross Cables.
4. Spread Drop Sheet over Cross Cables to protect the Tent Top.
5. Unfold Tent Top.
6. Attach Tent Top webbings to corner loops.
7. Install Posts. Secure with Lock Pin and insert the s-hook of the toggle rope into the hole at the Post Base.
8. Move Drop Sheet to clear Cross Cable intersection area
9. Insert Centrepole through the centre socket.
10. Install Flag from outside.
11. Install Centrepole over the Cross Cable intersecting point.
12. Remove and fold Drop Sheet.
13. Install remaining Posts.
14. Drive Stakes through each Post Base.
15. Tension each toggle rope.
16. Install Guy Ropes, Walls, Joiners.
17. Make final inspection to ensure everything is in operational condition.
18. Clean up site.

To take down the tent, reverse the preceding installation steps.

Care for your Vinyl Tops

Care for your vinyl tops as you would to any vinyl surface.

Use mild detergent industrial cleaner with no chlorox.

To clean, spread tent top on clean surface. Try laying fabric on astro turf to wash. Dirt and tiny sharp particles tend to fall into the carpet pile, away from the fabric. Some renters set up the tents to wash and dry.

Spray detergent solution onto fabric. Use more concentrated solution on soiled areas.

Rub, scrub or brush; elbow grease is an essential ingredient. Pressure washing may harm your tent fabric and is not recommended. Rinse with clean water, hang cover and allow to dry thoroughly.

DO NOT put your tent away damp. Mold & mildew will grow and discolour the cover. Always dry the tent. To speed things up, try fans or carpet air blowers and hanging the canopy.

Trees can be a problem with sap, pollen, etc. Flowers & leaves, sometimes contain powerful natural organic chemicals capable of staining your beautiful tent. Beware of tents under trees!

- Always use a drop sheet during setup and take down.
- Have some cleaning equipment with you for on-site clean ups.
- Besides being a fire hazard, BBQ's add a lot of grease and grime to the underside of the tent and are not recommended even with the walls off.

STORAGE - store vinyl canopies and other parts **clean** and **dry**.

Maintaining Your Tent

Your **WSSL Peak Marquee Tent** will serve your needs now and for many years to come. Tighten the top and walls to avoid wind flap and consequent wear on the fabric. Periodically the fabric should be cleaned; in place or when dismantled. Using mild detergent, water and a deck mop, clean wipe the fabric roof or walls. Let dry. Repair any damage to the fabric using a WSSL Fabric Repair Kit. Repair or replace any possible damaged frame parts.

TENT FABRIC CHARACTERISTICS

MILDEW - If mildew is detected, remove it immediately. Regardless of treatment, there is no way to absolutely stop fungus growth if it is prevalent in your area. No tent can be guaranteed not to mildew. Vinyl fabrics may mildew in storage if not properly stored. **BE SURE TENT IS CLEAN AND DRY BEFORE STORING IN A COOL, DRY PLACE.**

WATER RESISTANCE - WSSL tents are made of waterproof vinyl/polyester fabrics using waterproof welded seams. Because these fabrics are impervious to moisture, condensation may occur with some heaters and if the tent is poorly vented. Do not confuse water condensation with leakage especially on vinyl tents.

FLAME RESISTANT - All WSSL tent tops and walls are fire retardant. All WSSL tent fabrics satisfy ULC-S109, NFPA 701, and California fire marshal tests for fire resistance.

FADING-OPACITY - Variable sun conditions, exposures, types of materials and fabric finishes all influence the weathering of fabrics. WSSL fabrics have been chosen for their colour and opacity consistency and stability.

COLD CRACK - Chosen for their tolerance to cold cracking, our translucent fabrics remain flexible at temperatures below 0°F. The opaque fabrics are laminated and therefore become stiffer as the temperature drops. When the temperature is near 32°F, care should be taken in folding and moving the fabric to prevent cracking of the vinyl, especially the walls with windows.

Notes

WSSL TENTS

Warner Shelter Systems Limited creates fabric-clad structures to suit virtually every purpose, from special events, trade shows, catering and outdoor concerts to warehousing and industrial use. Our award-winning tents are user-friendly, durable and set-up quickly.

We have earned a reputation for providing a high level of service to customers since 1970. It is a pleasure to serve you. Please contact us for further information.



PEAK MARQUEE TENT

A favorite for special events, fairs, trade shows, and food service use. With its ease of setup and lightweight frame, the Marquee is user-friendly as well as attractive.

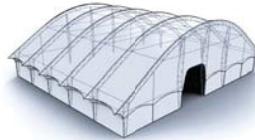

MODULAR CLEARSPAN BUILDING

Modular building Often used for large special events, but are equally suitable for warehousing, retail and industrial use and environmental projects. "MODS" are spacious and strongly built.



PEAK POLE TENT

Great Solution for large functions of all types, combining the nostalgic appeal of old fashioned circus "big tops" with the advantages of modern technology. Available in 40', 60', 80', and 90' widths.



ARABESQUE THEATRE TENT

The Arabesque Theatre with its high arched ends allows generous height over a stage at one end and bleacher seating at the other. These tents singularly or joined together, create a large attractive, clearspan interior.

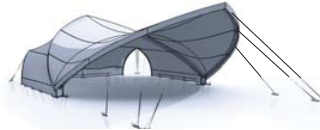

ARABESQUE STAGECOVER

The Arabesque Stagecover creates a striking backdrop for any outdoor concert with its dramatic curves and bold stripes. It is renowned for its superb acoustic projection and excellent sight lines.



DOMESTAGECOVER

With great acoustics and excellent sight lines, our attractive SC series is available in four sizes, with the SC-70A large enough to accommodate a full orchestra.



WSSL GIGA-SPAN

The WSSL Clearspan Series structures are designed, engineered, and manufactured in our CWB certified plant. The open web truss galvanized steel frames are assembled to satisfy the applicable building code.



TENT -C- CAN

The WSSL Tent -C- Can: For its 40 years anniversary Warner Shelter Systems Limited WSSL offers to the world with a NEW Warner Innovation.



WSSL GARAGE

WSSL Garage come complete with galvanized steel frame and fire retardant cover, easy to relocate structure featuring clear span truss framing, and 12' x 12' sliding door for easy access.



TENT-X-SPAN

Sturdy, versatile and portable, the Tent-X-Span fabric structures are light weight, easy to transport, store, and erect. Box beam aluminum frame, interchangeable parts, and easily joins to peak marquee tents.

Copyright © 2010 by Warner Shelter Systems Limited
All rights reserved.

This manual or any part thereof must not be reproduced in any form without the written permission of Warner Shelter Systems Limited.

The information contained in this manual is intended for the exclusive use of the customer and/or Building Authority.

Warner Shelter Systems Limited is not responsible for personal injury and damage to property caused by the application of the procedures documented in this manual to any situation not explicitly contemplated here.



Warner Shelter Systems Limited

Tents and Fabric-Clad Structures

9811 - 44th Street, SE, Calgary, Alberta, Canada T2C 2P7
Phone: (403) 279-7662 or (800) 661-6155; Fax: (403) 236-2633
Website: www.wssl.com • E-mail: warner@wssl.com