

Photo by Crown Party Rentals



# Peak Marquee™ Tents

Photo by Over the Top Tents & Events



Photo by A-mazing Decor



Photo by Titanium Tents

Photo by Windswept Promotions



Photo by All Shelter Sales and Rentals





# Peak Marquee™

## features

### ELEGANT AND TOUGH

Smooth graceful lines conceal a rental tough, durable, simple frame.

### INTERCHANGEABLE PARTS

Through twelve sizes from 100 to 1380 sq.ft., streamlining rental inventory.

### MODULARITY

Unique gutter system allows the tents to be joined in a variety of configurations.

### POLE FREE INTERIOR

The flying Centrepole supported by diagonal cables gives an obstruction free spacious interior.

### BATON SLIDING WALLS

Baton Sliding Walls slide and attach neatly to the post for an open side setup. The batons make carrying and installing walls quick and easy while reducing wear, tear and cleaning.

## specifications

### CANOPY:

Double curved for beauty and wind stability.

Fire retardant; satisfies ULC-S109 for National Building Code, also NFPA 701 large scale, California Fire Marshal.

Mildew and rot resistant.

Constructed of 18 oz. vinyl polyester with gloss self cleaning finish in a variety of colours including white and opaque.

Top pennant colour coordinated.

### CARRY BAGS:

Protective fabric cover bag with convenient handles for carrying.

### WALLS:

Fire retardant, 14 oz vinyl/polyester fabric. Sliding with batons or standard. Plain, mesh, clear vinyl, bay or french window; zipper and framed doors.

### JOINERS:

Our exclusive Downspout Gutter/Joiner forms a seal between linked tents keeping rain and drafts out.

### FRAMING:

Free standing frame. Anodized aluminum or electroplated steel interchangeable slip fit parts. No tools needed for assembly.

### HARDWARE:

Complete with all hardware and steel stakes.

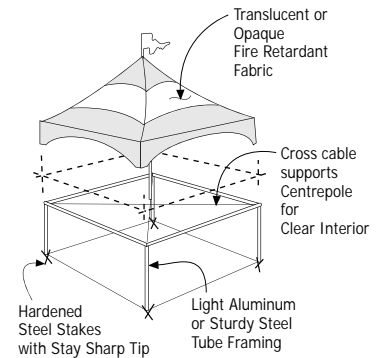

## The Peak Marquee™ Series

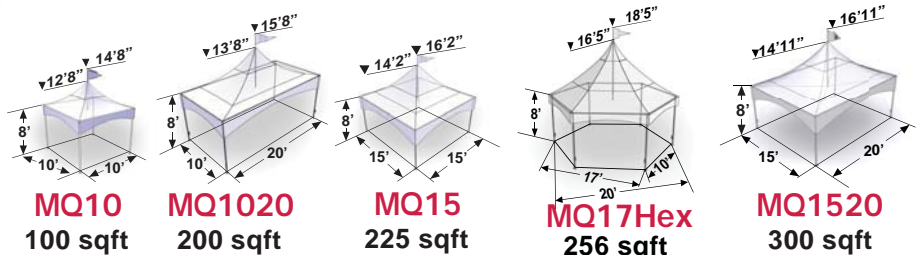

# Walls & Accessories

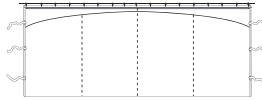

Wall: Plain

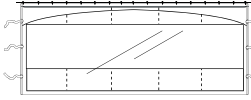

Wall: Clear

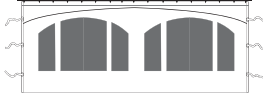

Wall: Bay Window

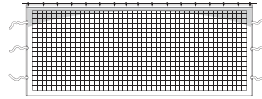

Wall: Mesh

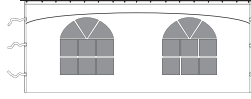

Wall: French Window

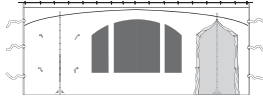

Wall: Bay Window w/ Zipper Doors

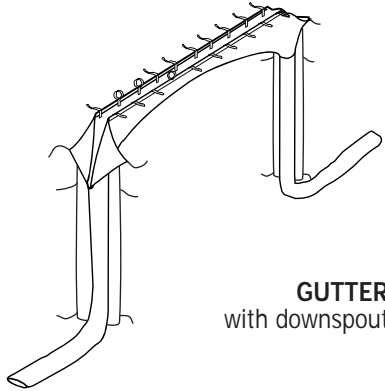

GUTTER with downspout

## exclusive Baton wall system

- very easy to install
- easy for customer to slide open and close
- velcro® for drafttight corners
- remains cleaner longer
- less wear, tear and window crack
- easy to fold, transport and store
- walls installed without loosening canopy

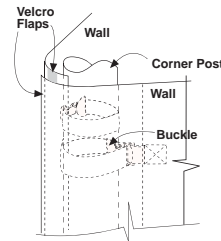

STANDARD WALL

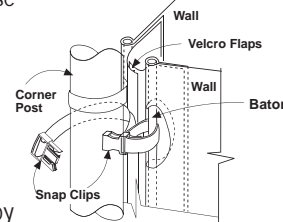
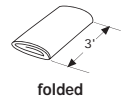

BATON WALL

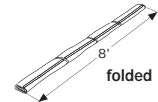

## layout suggestions

WSSL Peak Marquee tents can be joined together to form creative configurations, such as L-shapes, U-shapes, T-shapes or squares. Use your imagination.

MQ10H	MQ1015	MQ15	MQ1020	MQ1520	MQ20H	MQ2030T	MQ2040T	MQ30	MQ17HEX	MQ34HEX
10' X 10'	10' X 15'	15' X 15'	10' X 20'	15' X 20'	20' X 20'	20' X 30'	20' X 40'	30' X 30'	17' CROSS FLAT 20' POINT/POINT	35' CROSS FLAT 40' POINT/POINT

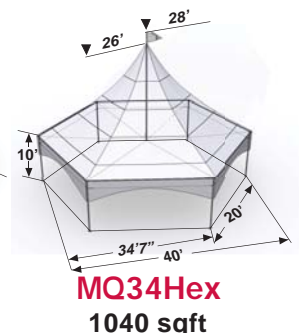
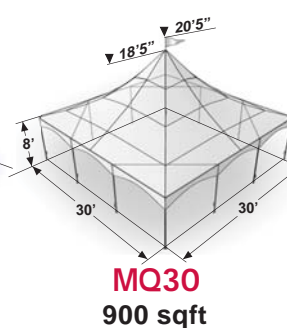
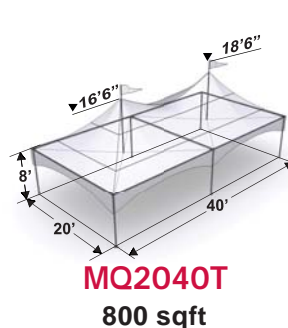
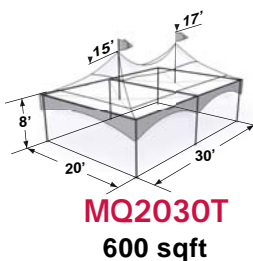
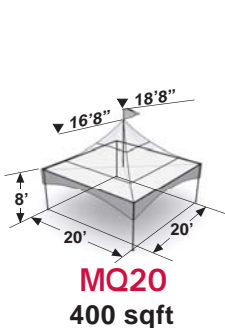
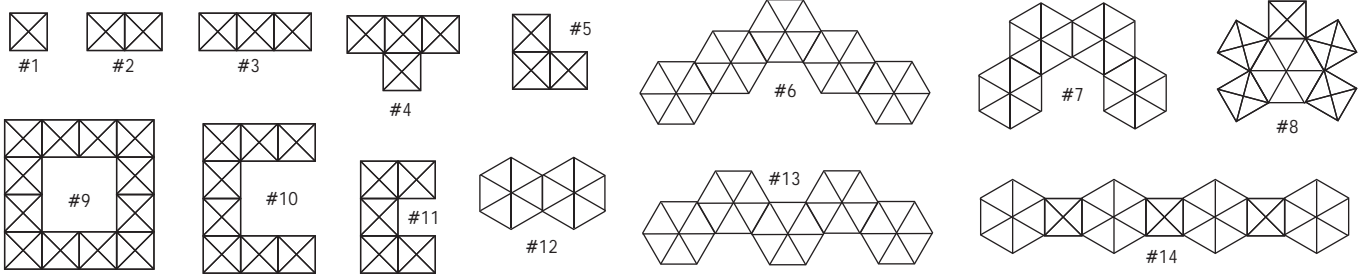



# Peak Marquee™ Tent Parts



## CANOPY

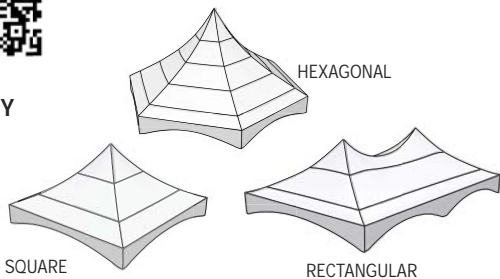

- **FABRIC**  
16 - 18 oz. Vinyl polyester  
Fire retardant ULC S109, NFPA 701
  - OPAQUE white for summer comfort
  - SKYLITE for natural lighting
  - COLOUR for festive display or corporate identity
- **COMPUTER DESIGNED SMOOTH CURVES**  
for elegance and pretensioned stability

## CENTREPOLE ASSEMBLY

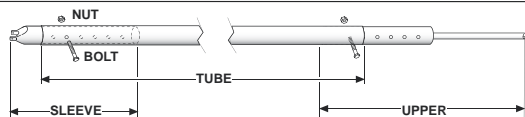

MQ10H	#10963	MQ2030T	#10978
MQ1020	#10595/#10963 (Alum)	MQ2040T	#10978
MQ15	#10898/#10963 (Alum)	MQ30	#10598
MQ1520	#10978	MQ34HEX	#10521
MQ17HEX	#10978		
MQ20H	#11544/#10978 (Alum)		

## POST ASSEMBLY

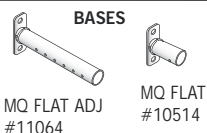

## POSTS



## T-JOINTS

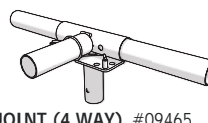
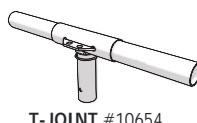
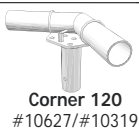
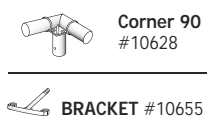

## MID JOINT



## EVE TUBES

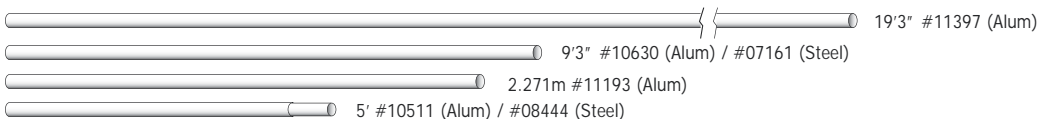

## BRACE EVES

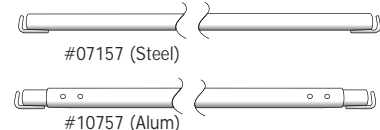

## CROSS CABLES



MQ10H	#7296	MQ2030T	#11818
MQ1020	#8704	MQ2040T	#11818
MQ15	#9471	MQ30	#7160
MQ1520	#11818	MQ34HEX	#7340
MQ17HEX	#12331		
MQ20H	#9275		

## STAKES

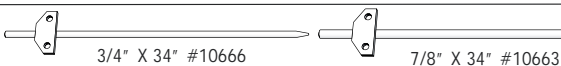

**IMPORTANT: EACH INSTALLATION SITE MUST BE EVALUATED AND PROPER SECURING METHOD DETERMINED BY THE INSTALLER. SITE CONDITIONS MAY REQUIRE ANCHORAGE DIFFERENT FROM WHAT IS SUGGESTED HERE.**

## ERECTING TOOLS

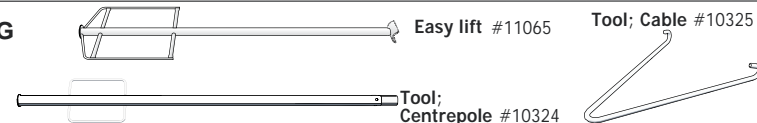

## GUYING



## Other WSSL tents & structures



## Warner Shelter Systems Limited

Tents and Fabric-Clad Structures

9811 - 44th Street, SE, Calgary, Alberta, Canada T2C 2P7  
Phone: (403) 279-7662 or (800) 661-6155; Fax: (403) 236-2633  
Website: www.wssl.com • E-mail: warner@wssl.com

