

# MODEL PPT 30X

---

# PEAK POLE TENT

8' SIDEPOLES OR 10' SIDEPOLES

## ASSEMBLY INSTRUCTIONS

### IMPORTANT:

PLEASE READ INSTRUCTIONS PRIOR TO ERECTING THE TENT.

PROPER INSTALLATION WILL ENSURE MAXIMUM USAGE AND STABILITY OF THIS STRUCTURE.

IF FURTHER INFORMATION OR CLARIFICATION OF ANY PART OF THE ENCLOSED INSTRUCTION IS REQUIRED, PLEASE CONTACT:

**WARNER SHELTER SYSTEMS LIMITED**  
1-800-661-6155 OR E-MAIL: [warner@wssl.com](mailto:warner@wssl.com)

### CAUTION

1. Each installation site must be evaluated and the proper securing method determined by the installer. Some soils require staking or securing different from that which was provided with the tent.
2. Good judgment and common sense must be used along with installation guidelines. It is the responsibility of the tent installer/maintainer to anticipate the severity of the weather along with the proper time and method of setup and take down. Evacuation of the tent is recommended before weather becomes extreme. A successful event is a safe event.
3. Proper safety equipment, such as hard hats, steel toe shoes, and safety glasses, should be used to ensure a safe setup and take down.

## Table of Contents

	<b>PAGES</b>	
1.) TENT LOCATION .....	<b>3</b>	
2.) PARTS LIST AND QUANTITIES .....	<b>4 - 5</b>	
3.) LAYOUT AND STAKING .....	<b>6 - 10</b>	
Assembly of Sidepoles and Centrepoles .....	PAGE 6	
Measure Layout .....	Step 1 .....	PAGE 6-8
Stake Layout .....	Step 2 .....	PAGE 9
Securing Stakes .....	Step 3 .....	PAGE 10
4.) TOPS; ENDS AND MIDS INSTALLATION .....	<b>9 - 14</b>	
Protecting Tops; Ends and Mids .....	Step 4 .....	PAGE 9
Unfolding Tops; Ends and Mids .....	Step 5 .....	PAGE 10-11
Installing Flag Pole .....	Step 6 .....	PAGE 11
Lacing .....	Step 7-9 .....	PAGE 12
Securing Tops; Ends and Mids .....	Step 10-13 .....	PAGE 13-14
5.) SIDEPOLE INSTALLATION .....	<b>14</b>	
6.) CENTREPOLE INSTALLATION .....	<b>15 - 16</b>	
7.) FINAL ADJUSTMENTS .....	<b>17</b>	
8.) SUMMARY .....	<b>18</b>	
9.) CARE FOR YOUR VINYL TOP .....	<b>18</b>	
10.) MAINTENANCE .....	<b>19</b>	

Copyright © 2004

by

Warner Shelter Systems Limited

*All rights reserved. This manual or any part thereof must not be reproduced in any form without the written permission of Warner Shelter Systems Limited*

*The information contained in this manual is intended for the exclusive use of the customer and/or Building Authority. Warner Shelter Systems Limited is not responsible for personal injury and damage to property caused by the application of the procedures documented in this manual to any situation not explicitly contemplated here.*

## Tent Location

### **VERY IMPORTANT!**

Ascertain tops, guys, and other tent parts are in good operating condition. **Any components showing visible damage should be replaced immediately.**

**Before unloading, review the proposed location of the tent. In doing so, take into account the following:**

#### **Hazards**

Locate, mark, and AVOID any overhead or underground electrical, phone, gas, sprinkler or other lines. Take note and always be aware of any and all hazards. **DO NOT BEGIN ANY ASSEMBLY UNTIL THE HAZARDS HAVE BEEN MARKED AND CAN BE SAFELY AVOIDED.**

#### **Access**

Review the setup equipment access. Plan the easiest route for the equipment for the setup procedure and for leaving the site afterward.

#### **Drainage**

Attempt to influence the location of the structure so that rain or melting snow can drain away.

#### **Obstacles**

The shape of the site, equipment, existing buildings and landscape can influence the setup of the tent. A clean, level and unobstructed site will provide for an easy assembly, setup, and use of your tent.

#### **Weather**

Do not attempt to setup the structure during thunderstorms, high wind or any other extreme conditions.

#### **Safety**

Before the set up, instruct the crew on safety procedures. All local safety and fire regulations must be followed.

**ALL SITE PERSONNEL MUST FOLLOW OCCUPATIONAL HEALTH AND SAFETY PROCEDURES.**

# MODEL PPT30X PEAK POLE TENT

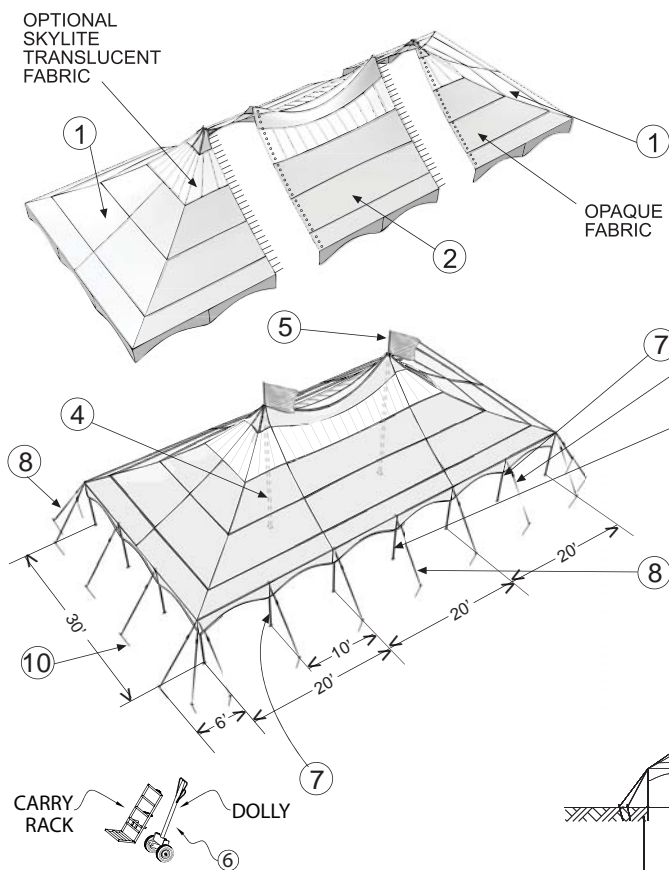

GUYING WITH WEBBING AND RATCHETS FOR MORE ACCURATE FABRIC PRESTRES

SIDE POLES AND WALLS ARE INTERCHANGEABLE WITH WSSL PEAK MARQUEE TENT

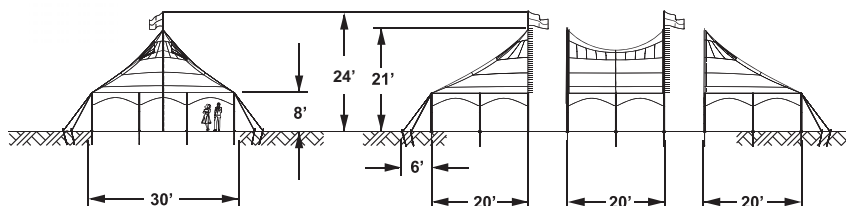
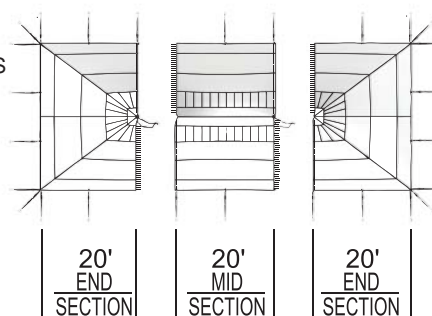

## PARTS LIST & QUANTITIES

			ASSEMBLY #	11733	11732	70801	11734	11735
PART			WEIGHT lb (kg)	30X40	30X90	30X100	ADD'L 20' MID	ADD'L 30' MID
①	TOP END	30'X20'	11736	154 (70)	2	2	2	-
②	TOP MID	30'X20'	11737	146 (66)	-	1	-	1
③	TOP MID	30'X30'	11738	203 (92)	-	1	2	-
④	CENTERPOLE	3 PIECE ASSEMBLY	11102	106 (48)	1	3	3	1
		5 PIECE ASSEMBLY	11170	119 (54)				
⑤		FLAGPOLE	10782	1.3 (0.6)	1	3	3	1
⑥		DOLLY, CENTERPOLE	11103	84 (38)	1	1	1	-
⑦	SIDE POLE	ALUM 2.5"X 8'	10884	10 (4.6)	14	24	26	4
⑧	GUYING	RATCHET WEBBING (HOOK)	12065	5 (2.3)	22	32	34	4
		RATCHET WEBBING (LOOP)	11145					
⑩	STAKES	1"X42" TRIBAR	11053	10 (4.6)	22	32	34	4
WEIGHT lb (kg)				981 (445)	1850 (839)	1924 (873)	366 (166)	476 (216)

## PARTS LIST

### TOPS; END AND MID

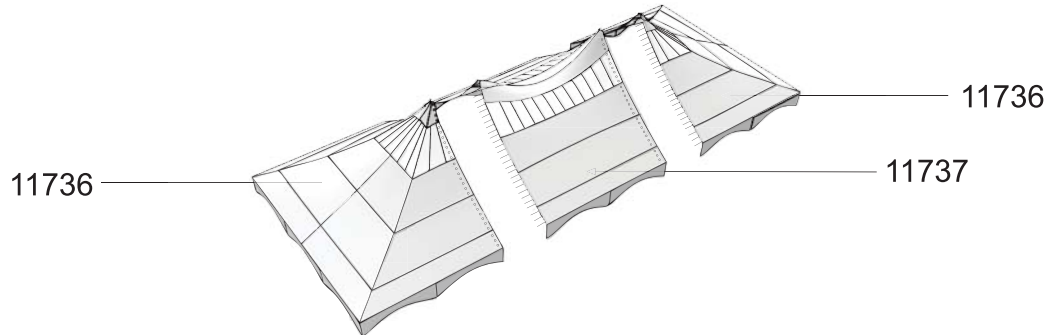

CENTREPOLES	5 pc assembly 11170	11770 BASE	11165 LOWER 6'	11166 MID 6'	11165 UPPER 6'	10745 UPPER	10782 FLAGPOLE
-------------	------------------------	---------------	-------------------	-----------------	-------------------	----------------	-------------------

SIDETOPES		10514 BASE	11765 (10') TUBE	10237 CROWN AND CROWN NUT
# 11764	ALUM 2.5"X10'			
# 10884	ALUM 2.5"X8'	10514 BASE	10591 (8') TUBE	10237 CROWN AND CROWN NUT

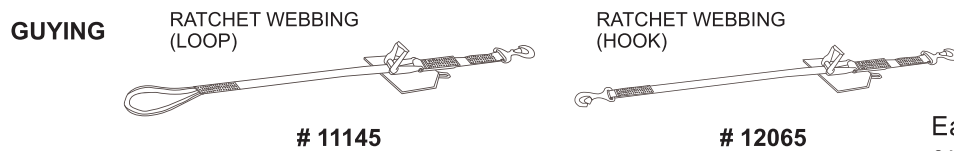

**\* IMPORTANT:**  
Each installation site must be evaluated by installer to determine proper securing method. Site conditions may require guying and anchorage different from what was provided with the tent.

STAKES	4001 STAKE CAP	10663 7/8" X 34" TRIBAR	11053 1" X 42" TRIBAR	11180 1" X 42" DOUBLE HEAD
--------	-------------------	-------------------------------	-----------------------------	----------------------------------

### DOLLY with RACK # 11103

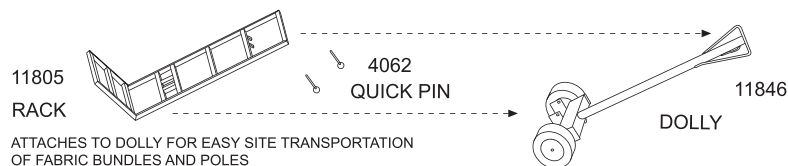

## Tools required for setup:

- 1 can of bright colour spray paint
- 2 sledge hammers
- 2 100' tape measures
- 2 50'x1/2" Poly Ropes

for initial assembly only { 2 3/4 inch open wrenches  
2 1/2 inch open wrenches

## INITIAL ASSEMBLY OF SIDEPOLES AND CENTREPOLES

### Sidepoles

- Assemble sidepoles.

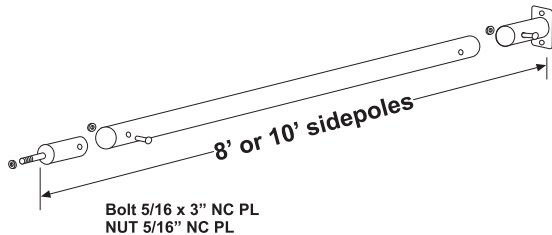

### Endpoles

- Assemble centrepoles

Centrepole length:  
21' for 8' sidepole  
23' for 10' sidepole

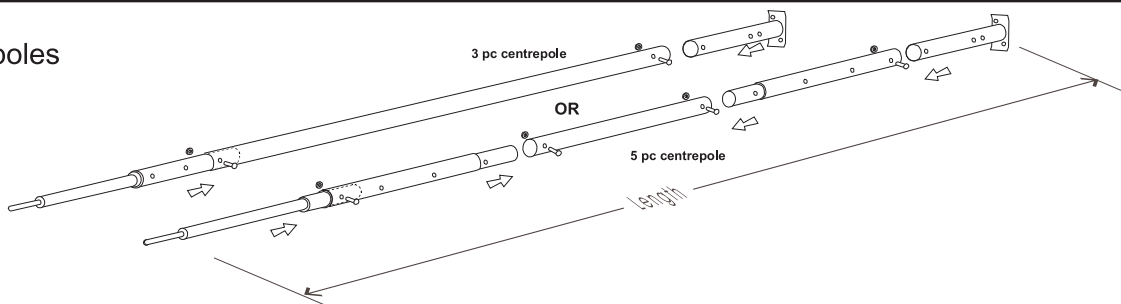

## PERIMETER LAYOUT

### Step 1

For fast and efficient tent installation, measure and mark site **BEFORE** laying out tent.

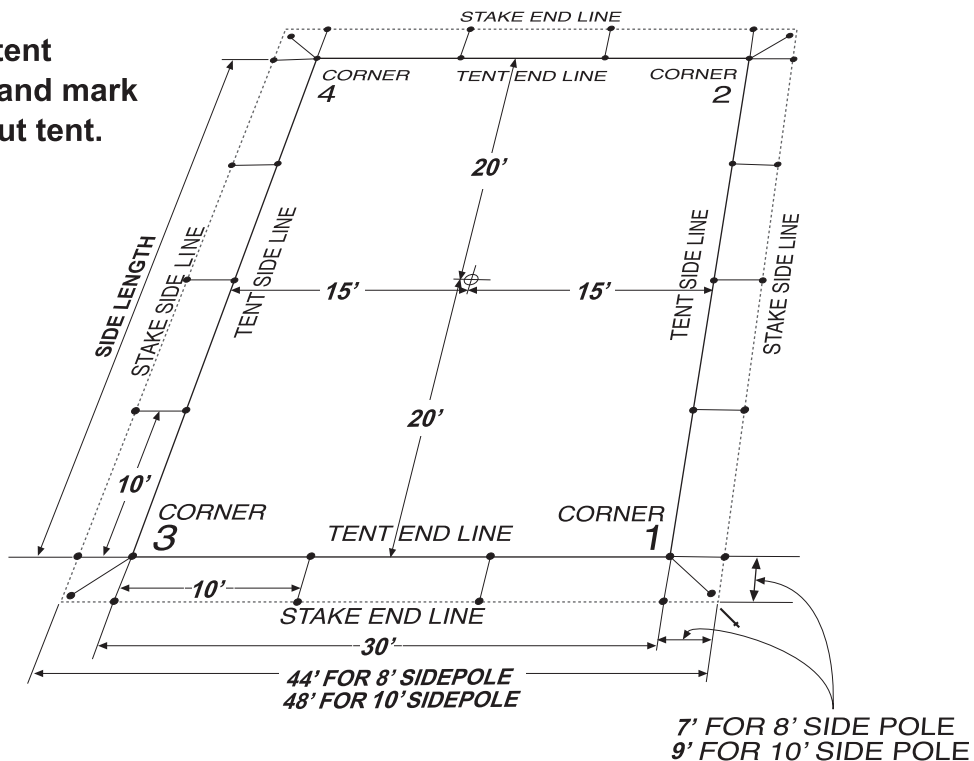

**REQUIREMENTS:**

- |  |   |
|--|---|
| <ul style="list-style-type: none"> <li>• 4 stakes</li> <li>• 2 100' tapes</li> </ul> | <ul style="list-style-type: none"> <li>• Sledge hammer</li> <li>• Marker paint</li> </ul> |
|--|---|

**CAUTION:**

Before beginning any installation, locate, identify and AVOID all hazards and obstructions. DO NOT SETUP IN HAZARDOUS AREAS. Take general tent measurements to determine that tent will fit into space.

**1.) Locate and mark corner 1.**

Mark corner with marker paint and stake.



**2.) Locate and mark tent side line.**

From corner 1, measure length of tent mark corner 2.

Mark 10' increments along line between corners 1 and 2.

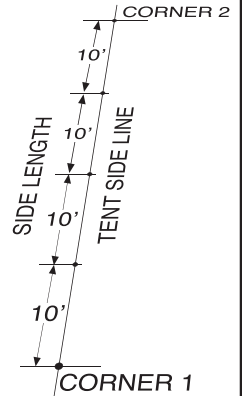

**3.) Locate and mark tent end line.**

- From corner 1 mark 30' arc perpendicular to tent side line.
- From 40' point along side line measure 50' intersecting 30' arc.
- Mark 10' increments along side and end.

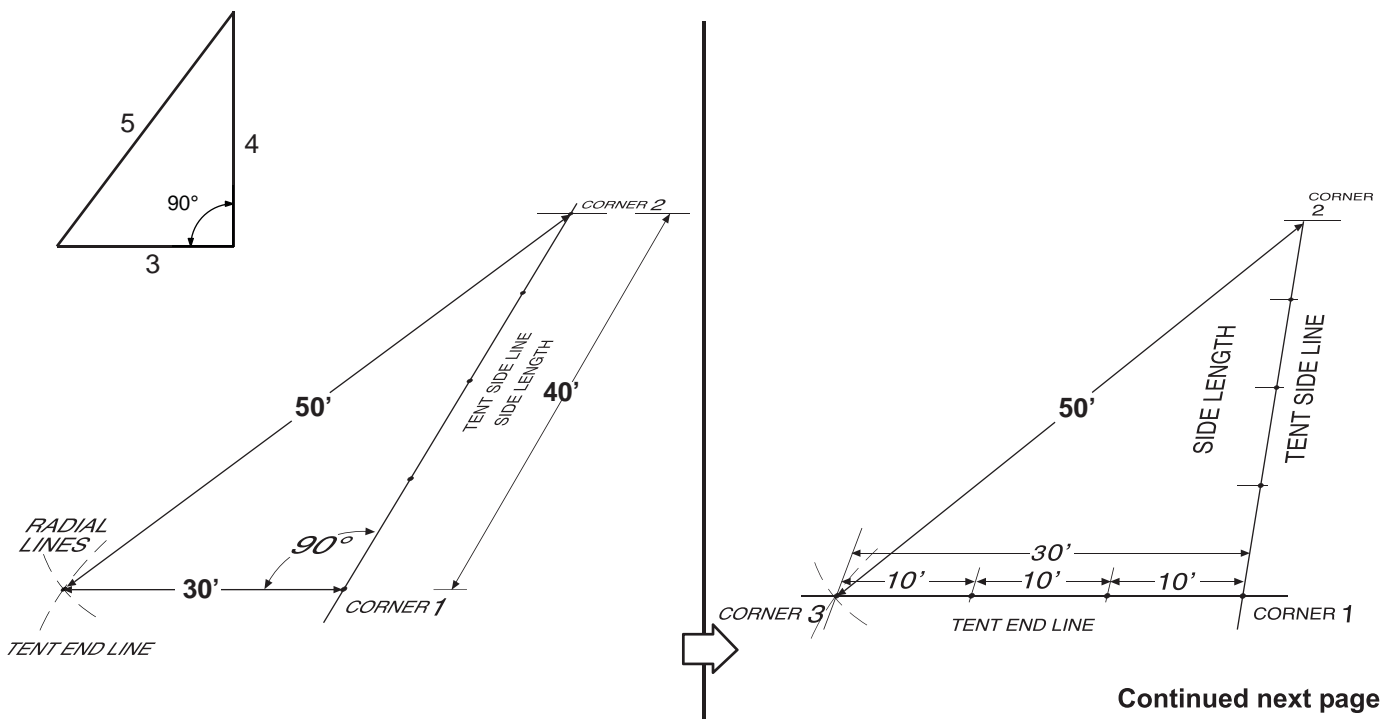

Continued next page

**4.) Locate and mark corner 4 and opposite tent lines.**

- a.) From corner 3 measure tent side length and mark arc.
- b.) From corner 2, measure end 30' to arc and mark intersecting point.
- c.) Check your tent layout: diagonal 1 to 4 should equal 2 to 3.
- d.) Mark tent side and end lines at 10' increments.

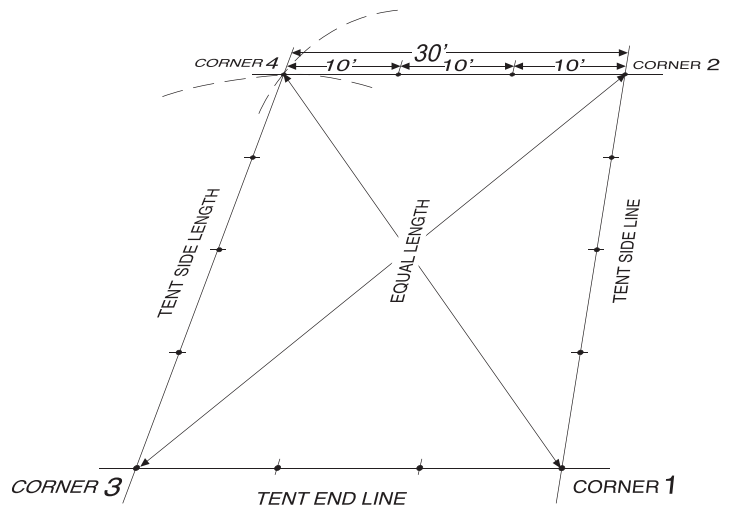

**5.) Locate centrepole locations**

- a.) Measure and mark centrepole locations.

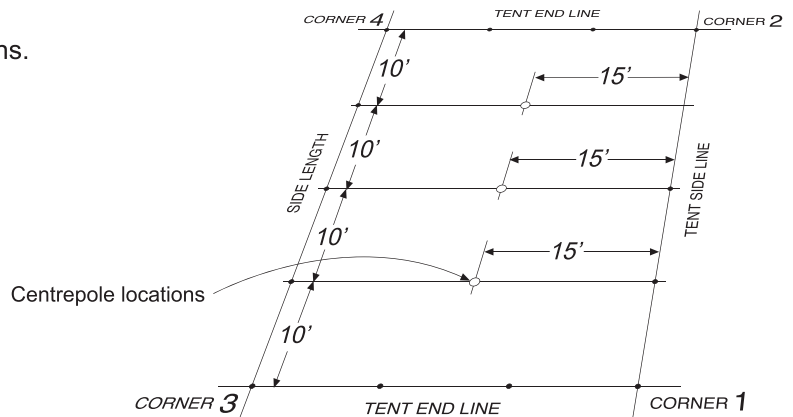

**6.) Locate stakeline with the sidepoles**

- a.) Measure 7' (for 8' sidepole) or 9' (for 10' sidepole) outward from side and end lines at each corner and mark each location with spray paint.
- b.) Measure and mark 10' increments along side and end lines.

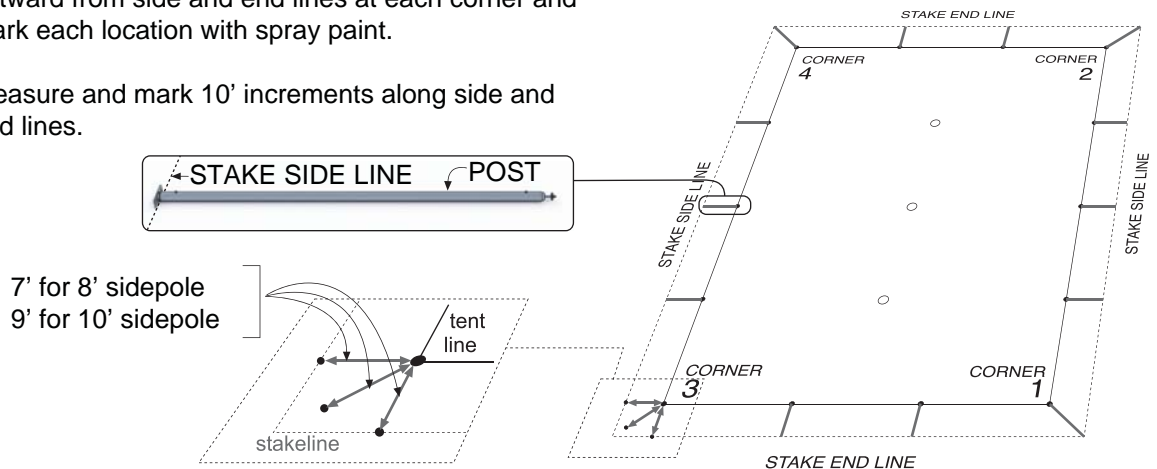



## Step 2

- Layout stakes as shown. =>

### IMPORTANT

Each installation site must be evaluated by installer to determine proper securing method. Site conditions may require guying and anchorage different from what was provided with the tent.

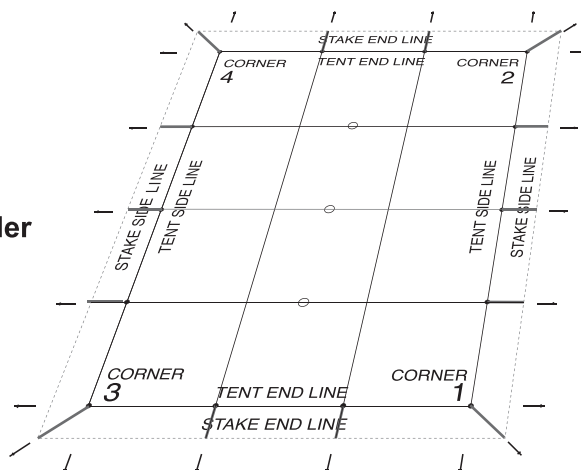

## Step 3

- Install stakes as required.
- Ground conditions effect the performance of the stakes. The number of stakes or other anchorage required may be different from that shown here.



## Step 4

- Lay down drop sheet.
- \* **USE OF DROP SHEET REDUCES CLEANING AND INCREASES COVER LIFE.**

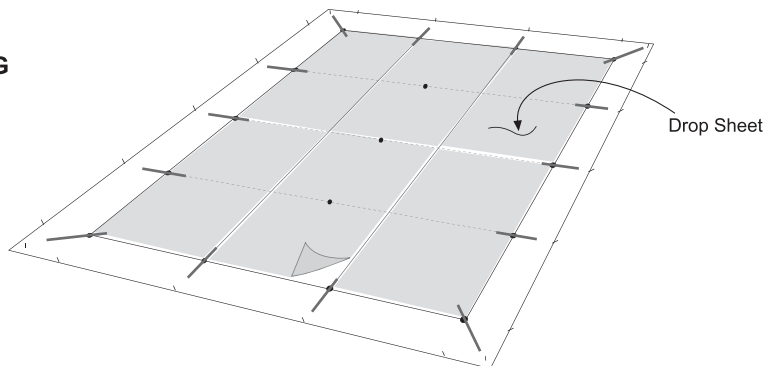

## Step 5

- Position Tops; Ends; and Mid bundles and unroll in the direction shown.
- Unfold ends and mids as shown.

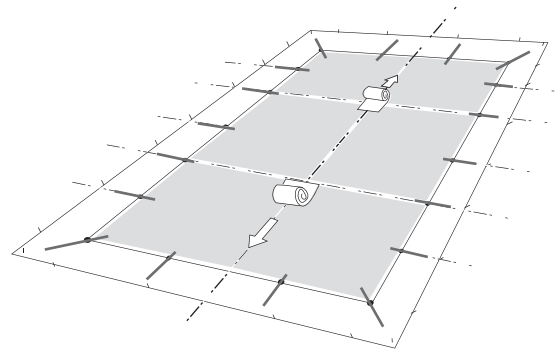
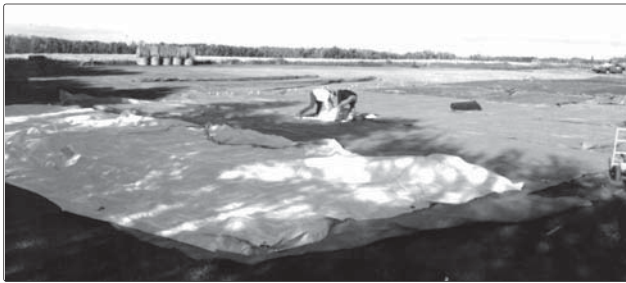

### UNFOLDING THE CANOPY

#### END SECTIONS

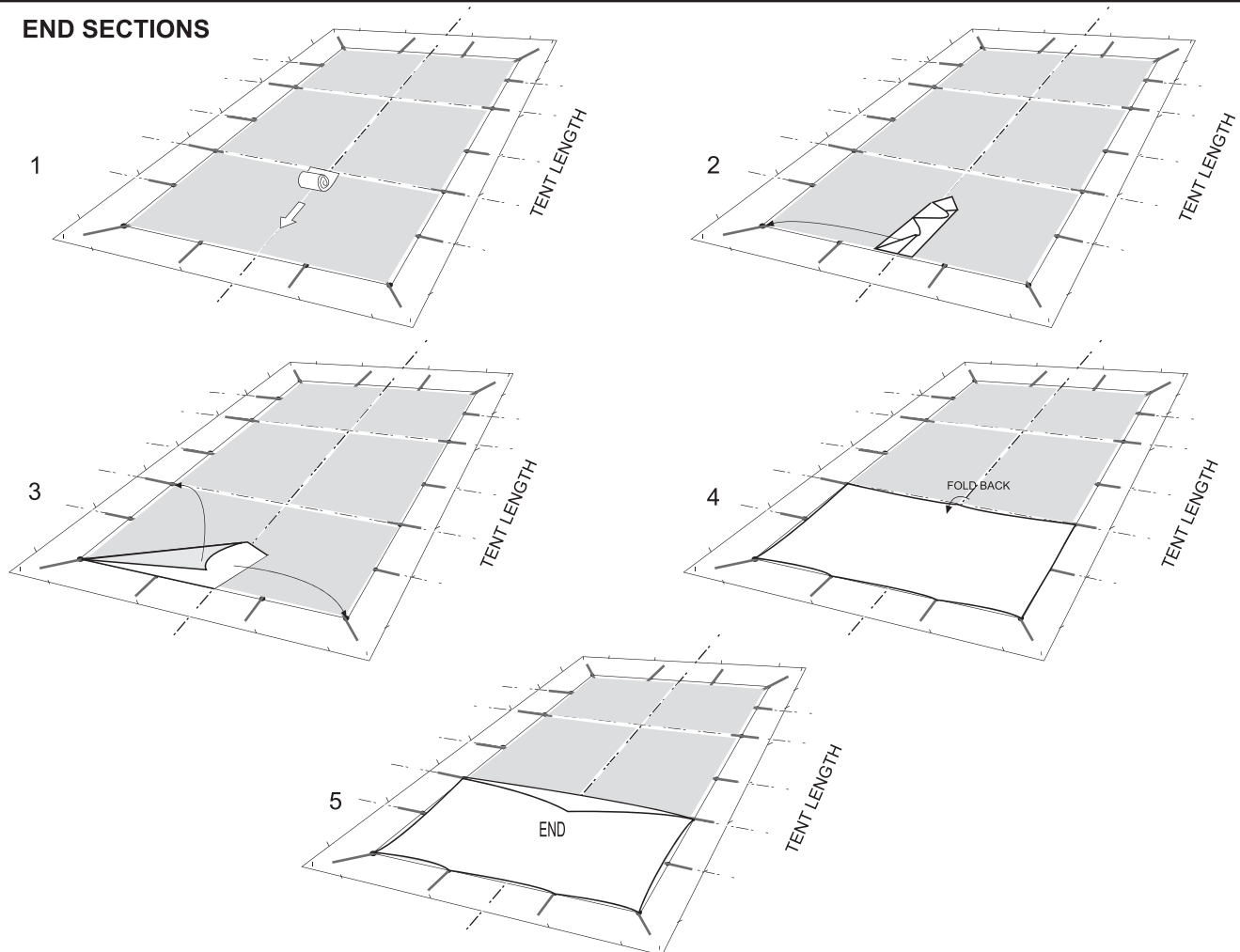

## UNFOLDING THE CANOPY

\*only one mid section was used in this illustration

### MID SECTION(S)

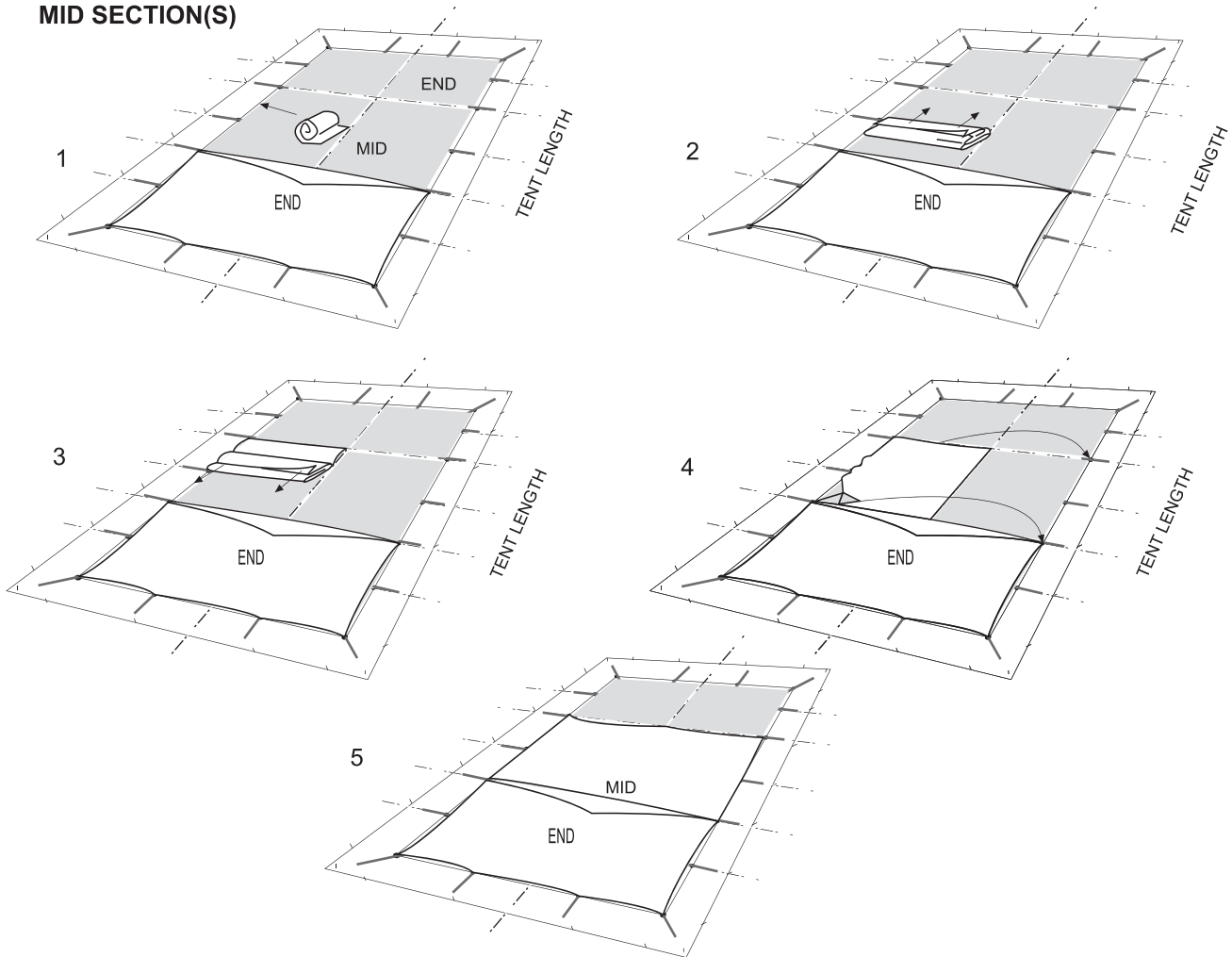

## FLAG POLE INSTALLATION

### Step 6

- Overlap centre plates and insert flagpole through plate holes from underneath.

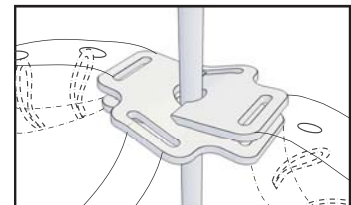
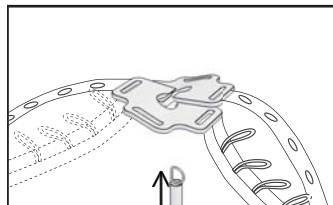
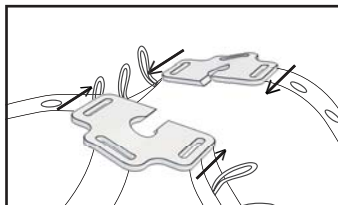

## LACING

### Step 7

- Start lacing from the flagpole by inserting cord loop up through corresponding grommets using a daisy chain process.



Daisy chain lacing



### Step 8

- Tie off last lacing loop.



### Step 9

- Continue the same process for the rest of the lace lines. =>
- Overlap flaps and snap clip from top flap to the rope at the bottom flap.
- Attach flags.  
(not supplied)



## Step 10

- Interlock joining plates and attach S-hook from the top canopy to the bottom plate.

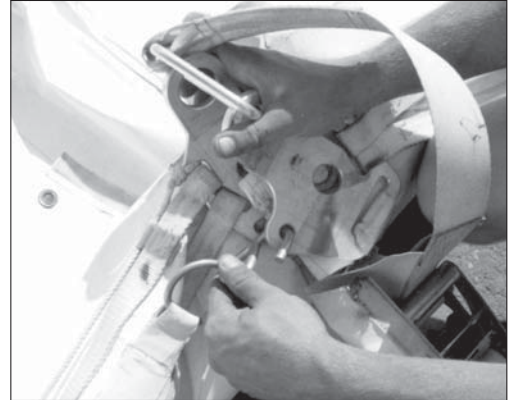
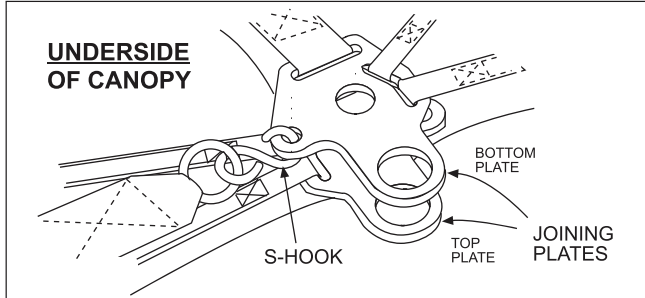

## Step 11

- Install webbing to stake bars, 1 per laceline and side.

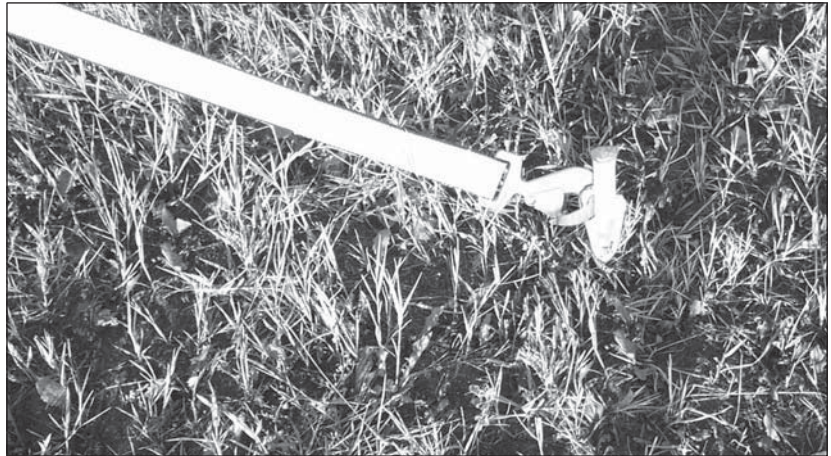

## Step 12

- Snap each webbing hook to corresponding plate.

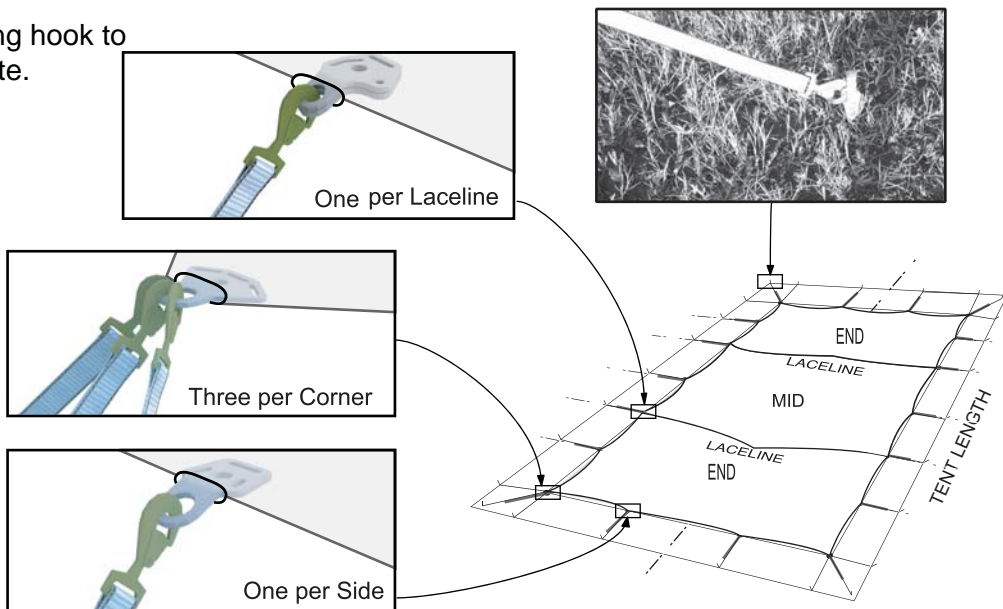

## Step 13

- Starting at a corner, insert sidepoles to corresponding plates and secure each with a nut.

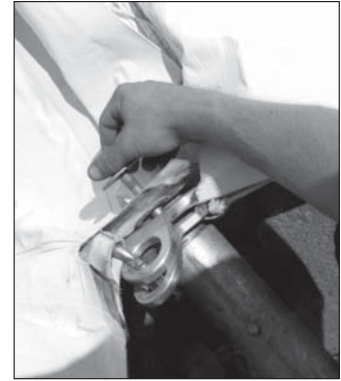
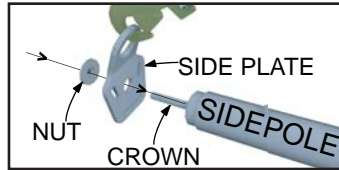

## Step 14

- Starting with the corners, place sidepole base at previously determined mark.
- Tighten the guy webbing straps keeping the top of sidepole leaning 8" - 10" inward.
- After all (4) corners are installed using webbing guys, adjust each to approach vertical.

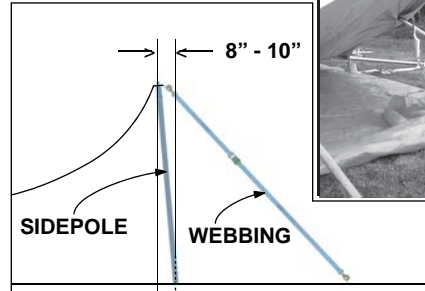

## Step 15

- Continue placing the rest of the sidepole bases to corresponding marks starting with the lace lines (2) on each side and the rest after (3, 4 & 5), again leaving top of the poles leaning 8" inward.

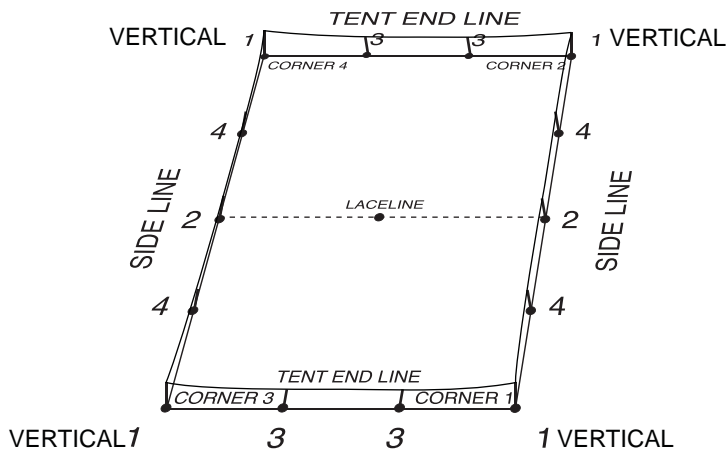

Bases of sidepoles exactly on previously marked positions.



## Step 16

- Place centrepole base on the dolly and insert stake through hole in base and dolly.

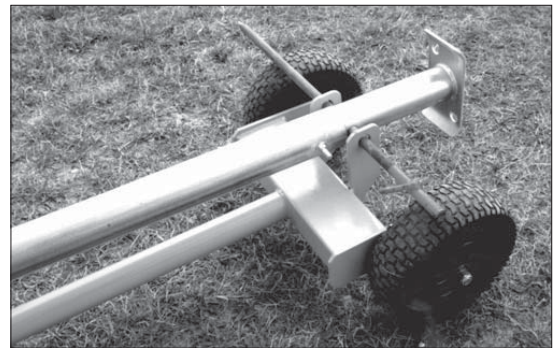
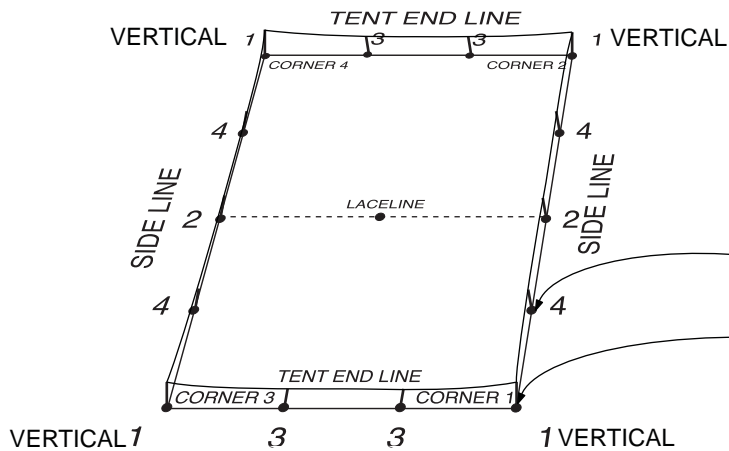

Sidepoles are slanted inward 8" - 10"

Corner sidepoles are vertical

## Step 17

- Insert upper end of centrepole through corresponding flagpole.

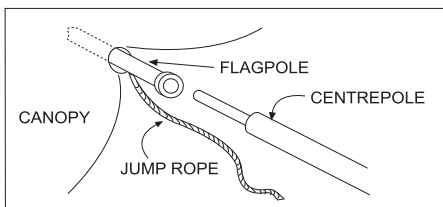

## Step 18

**VERY IMPORTANT!**

- Secure jump rope to centrepole before raising.

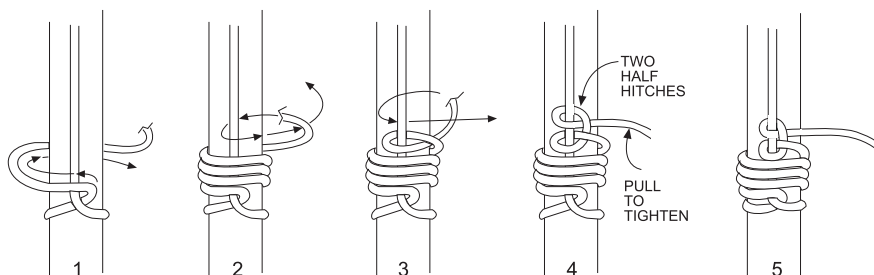

## Step 19

### RAISING THE CENTREPOLE

Recommended ways in raising the centrepoles are:

- manually starting with a shortened centrepole
- using a winch, pickup truck, or other appropriate vehicle.

Use whichever is most applicable depending on the availability of personnel and equipment.

### SHORTENING FIRST CENTREPOLE LENGTH

- Shortening the length of the first centrepole reduces tension and force needed to raise it.

To reduce centrepole height, insert upper tubing to the middle tube and secure with nut and bolt.

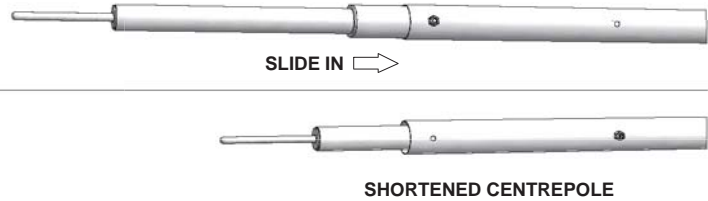

If using an appropriate vehicle.

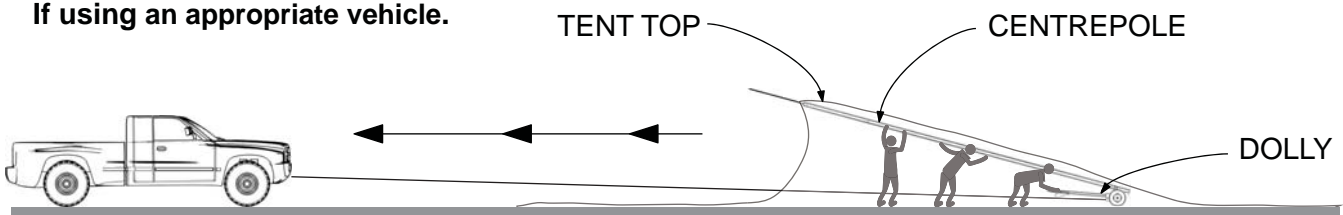

- To erect centrepole, attach a rope to the ring at the bottom of the dolly.
- Pull on rope and carefully raise centrepole, watching the flagpole is clear of the fabric folds.
- With two men raising the top end of the centre-pole, pull dolly until centrepole base is right at the corresponding marked location.
- Slowly raise the dolly handle up to lower centrepole to the ground and remove stake.
- Continue to install the rest of the centre-poles using the same procedure.
- If shortened first centerpole method is used, with all centrepoles raised, take down the shortened centrepole, and adjust to proper height and reinstall.





## Step 20

- Tighten the ratchet webbing straps. Sidepoles should be vertical upon completion.

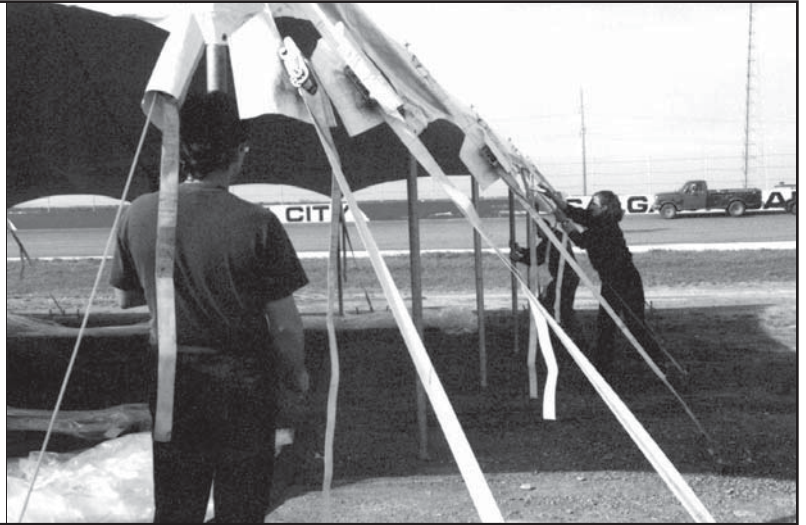

## Step 21

- Fold up loose webbing and secure flaps.

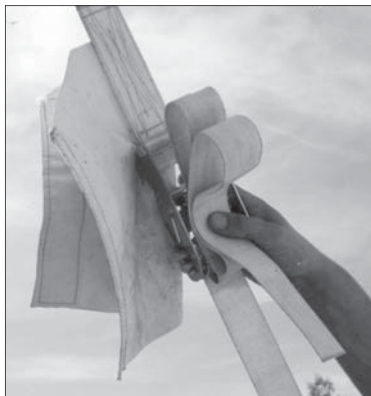

## Step 22

- Re-check all poles, ropes, webbings and canopies, to ensure that everything is in operational condition.
- Due to changes in weather, periodic inspection and, if necessary, adjustments should be made.
- To take down the tent, reverse the preceding steps.



Photo by Special Event Rentals

## Summary

1. Mark location of poles and anchor bars.
2. Layout stake bars and drive in stakes.
3. Lay down drop sheet.
4. Unfold top ends and top mids.
5. Insert flag pole through centre plates.
6. Daisy chain all lacelines.
7. Install flag
8. Attach guy webbing to stake bars.
9. Assemble and attach side poles
10. Attach guy snap to side plates.
11. Erect side poles starting with the four corners, then lacelines, then the rest (8" - 10" inward lean).
12. Assemble and install centrepoles.
13. Adjust webbings to straighten side poles.
14. Remove and fold drop sheet.
15. Install any required centrepole and side pole stakes.
16. Install walls and gutters if required.
17. Make final inspection to ensure everything is in operational condition.
18. Clean up site.

## Care for your Vinyl Tops

### Care for your vinyl tops as you would any vinyl surface.

Use mild detergent industrial cleaner with no chlorox.

To clean, spread canopy on clean surface. An astro turf surface is recommended for washing. Dirt and tiny sharp particles tend to fall into the carpet pile, away from the fabric. Some renters set up the tents to wash and dry.

Spray detergent solution onto fabric. Use more concentrated solution on soiled areas.

Rub, scrub or brush; elbow grease is an essential ingredient. Pressure washing may harm your tent fabric and is not recommended. If possible hang cover and allow to dry thoroughly.

**DO NOT put your tent away damp.** Doing so may allow mold and mildew to grow and discolour the cover. Always dry the tent. To speed things up, try fans or carpet air blowers and hanging the canopy.

Trees can be a problem with sap, pollen, etc. Flowers and leaves, sometimes contain powerful natural organic chemicals capable of staining your

tent. Beware of tents under trees!

- Always use a drop sheet during setup and take down.

- Have some cleaning equipment with you for the on-site clean ups.

- BBQ's add a lot of grease and grime to the underside of the tent and is not recommended - even with the walls off.

**STORAGE** - store vinyl canopies and other parts **clean and dry.**

**WEATHER EFFECTS** - the customer should be aware of the local weather and the effect it might have on the tent.

**WIND** Wind can cause the tension of the tent to change.

**RAIN** If not tensioned properly, rain can sometimes collect on the tent, causing 'ponding' and undue stress on the canopy.

**SNOW** Traditional pole supported tents are not designed to carry snow load. Proper precautions should be taken so that no snow collects on the tent.

## Maintaining Your Tent

Your **WSSL Peak Pole Tent** will serve your needs now and for many years to come. Tighten the top and walls to avoid wind flap and consequent wear on the fabric. Periodically the fabric should be cleaned; in place or when dismantled. Using mild detergent, water and a deck mop, clean wipe the fabric roof or walls. Let dry. Repair any damage to the fabric using a WSSL Fabric Repair Kit. Repair or replace any possible damaged frame parts.

### TENT FABRIC CHARACTERISTICS

**MILDEW** - If mildew is detected, remove it immediately. Regardless of treatment, there is no way to absolutely stop fungus growth if it is prevalent in your area. No tent can be guaranteed not to mildew. Vinyl fabrics may mildew in storage if not properly stored. **BE SURE TENT IS CLEAN AND DRY BEFORE STORING IN A COOL, DRY PLACE.**

**WATER RESISTANCE** - WSSL tents are made of waterproof vinyl/polyester fabrics using waterproof welded seams. Because these fabrics are impervious to moisture, condensation may occur with some heaters and if the tent is poorly vented. Do not confuse water condensation with leakage especially on vinyl tents.

**FLAME RESISTANT** - All WSSL tent tops and walls are fire retardant. All WSSL tent fabrics satisfy ULC-S109, NFPA 701, and California fire marshal tests for fire resistance.

**FADING-OPACITY** - Variable sun conditions, exposures, types of materials and fabric finishes all influence the weathering of fabrics. WSSL fabrics have been chosen for their colour and opacity consistency and stability.

**COLD CRACK** - Chosen for their tolerance to cold cracking, our translucent fabrics remain flexible at temperatures below 0°F. The opaque fabrics are laminated and therefore become stiffer as the temperature drops. When the temperature is near 32°F, care should be taken in folding and moving the fabric to prevent cracking of the vinyl, especially walls with windows.

A tent is a temporary structure and the responsibility for its security rests with the customer. Periodic inspections of a tent installation are important.

Should you have further questions or concerns, please contact us at:



## **Warner Shelter Systems Limited**

*Tents and Fabric-Clad Structures*

9811 - 44th Street, SE, Calgary, Alberta, Canada T2C 2P7  
 Phone: (403) 279-7662 or (800) 661-6155; Fax: (403) 236-2633  
 Website: [www.wssl.com](http://www.wssl.com) • E-mail: [warner@wssl.com](mailto:warner@wssl.com)

## WSSL TENTS

Warner Shelter Systems Limited creates fabric-clad structures to suit virtually every purpose, from special events, trade shows, catering and outdoor concerts to warehousing and industrial use. Our award-winning tents are user-friendly, durable and set-up quickly.

We have earned a reputation for providing a high level of service to customers since 1970. It is a pleasure to serve you. Please contact us for further information.



### PEAK MARQUEE TENT

A favorite for special events, fairs, trade shows, and food service use. With its ease of setup and lightweight frame, the Marquee is user-friendly as well as attractive.



### MODULAR CLEARSPAN BUILDING

Modular building Often used for large special events, but are equally suitable for warehousing, retail and industrial use and environmental projects. "MODS" are spacious and strongly built.



### PEAK POLE TENT

Great Solution for large functions of all types, combining the nostalgic appeal of old fashioned circus "big tops" with the advantages of modern technology. Available in 40', 60', 80', and 90' widths.



### ARABESQUE THEATRE TENT

The Arabesque Theatre with its high arched ends allows generous height over a stage at one end and bleacher seating at the other. These tents singularly or joined together, create a large attractive, clearspan interior.

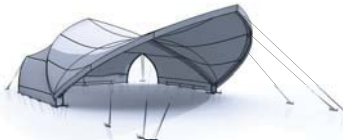

### ARABESQUE STAGECOVER

The Arabesque Stagecover creates a striking backdrop for any outdoor concert with its dramatic curves and bold stripes. It is renowned for its superb acoustic projection and excellent sight lines.



### DOMES STAGECOVER

With great acoustics and excellent sight lines, our attractive SC series is available in four sizes, with the SC-70A large enough to accommodate a full orchestra.



### WSSL GIGA-SPAN

The WSSL Clearspan Series structures are designed, engineered, and manufactured in our CWB certified plant. The open web truss galvanized steel frames are assembled to satisfy the applicable building code.



### TENT -C- CAN

The WSSL Tent -C- Can: For its 40 years anniversary Warner Shelter Systems Limited WSSL offers to the world with a NEW Warner Innovation.



### WSSL GARAGE

WSSL Garage come complete with galvanized steel frame and fire retardant cover, easy to relocate structure featuring clear span truss framing, and 12' x 12' sliding door for easy access.



### TENT-X-SPAN

Sturdy, versatile and portable, the Tent-X-Span fabric structures are light weight, easy to transport, store, and erect. Box beam aluminum frame, interchangeable parts, and easily joins to peak marquee tents.



## Warner Shelter Systems Limited

*Tents and Fabric-Clad Structures*

9811 - 44th Street, SE, Calgary, Alberta, Canada T2C 2P7  
Phone: (403) 279-7662 or (800) 661-6155; Fax: (403) 236-2633  
Website: [www.wssl.com](http://www.wssl.com) • E-mail: [warner@wssl.com](mailto:warner@wssl.com)